

Singer 96-80

Singer 96-86

Singer 96-100

Form 19118
(1137)
Printed in U. S. A.

HISTORICAL COPY
DO NOT REMOVE

LIST OF PARTS



MACHINES
Nos. 96-80, 96-86
and 96-100

THE SINGER MANUFACTURING COMPANY

INSTRUCTIONS FOR OILING

Use only Singer "Oil For High Speed Sewing Machines (Cloth and Leather)" for general use, or "Stainless Oil For High Speed Sewing Machines" where a stainless oil is desired.

Oil should be applied to all oil holes and bearings of the machine at least four times a day. Keep all wicking saturated with oil.

The upper and lower gears of the upright arm shaft should be greased with Singer Gear Lubricant every 160 hours of operation, using an Alemite-Zerk grease gun as instructed in Form 19068.

Copyright, U. S. A., 1921, 1922, 1933,
1935 and 1937
by The Singer Manufacturing Co.
All Rights Reserved for all Countries

INDEX

	Page
Accessories.....	17
Binder on Shank.....	21
Binder (Transverse) on Shank.....	21
Bobbin Winders.....	18
Finger Guards.....	22
Foot Lifter Parts.....	25
Hemmers (Foot).....	22
Hemmers on Shank.....	23
Knee Lifter Parts.....	27
Machine Base.....	17
Machine No. 96-80.....	5
Machine No. 96-86.....	14
Machine No. 96-100.....	15
Numerical List of Parts.....	29
Piping Attachment.....	24
Presser Feet.....	24
Ruffler.....	24
Thread Unwinder.....	28

INSTRUCTIONS FOR ORDERING

In ordering from this list, use ONLY the part NUMBER in the FIRST column.

The number stamped on a Sewing Machine Part is in every case the number of the single part only.

Every combination of parts sent out as such has its specific number, which, although not stamped on the parts, must be used when ordering the combination.

Each number always indicates the SAME PART in whatever list it appears, or for whatever machine.

The letters after some of the numbers indicate the style of finish only, as follows:

- A-Hardened, Polished, Nickel Plated and Buffed
- B-Polished, Nickel Plated and Buffed
- C-Hardened Only
- D-Polished Only
- E-Soft, Not Polished
- F-Hardened and Polished
- F.J-Hardened, Polished and Nickel Plated
- G-Bright Rumbled and Nickel Plated
- H-Blued
- J-Nickel Plated Only
- K-Hardened and Nickel Plated
- L-Brass Plated
- M-Oxidized
- N-Japanned, Dull
- P-Japanned, Bright
- R-Merlized
- S-Cadmium Plating
- T-Copper Plated
- T.A-Hardened, Polished, Copper and Nickel Plated and Buffed
- T.B-Copper and Nickel Plated and Polished
- T.J-Copper and Nickel Plated Only
- T.K-Hardened, Copper and Nickel Plated
- T.L-Copper and Brass Plated
- T.M-Copper Plated and Oxidized
- U-Zinc Plated
- V-Silver Plated
- W-Polished and Nickel Plated
- X-Black Oxide, for Iron and Steel
- X.C-Hardened and Black Oxide, for Iron or Steel
- Y-Black Nickel Plated Only
- Z-Chromium Plated
- Z.A-Hardened, Polished, Nickel Plated, Buffed and Chromium Plated
- Z.B-Polished, Nickel Plated, Buffed and Chromium Plated
- Z.C-Hardened and Chromium Plated
- Z.J-Nickel and Chromium Plated

These letters MUST BE USED when they appear in the list; and AFTER the number as in the list.

In this series:

1 to 1500, 50001 to 51500 and 140001 to 142000 are Screw Numbers
 1501 to 1800 and 51501 to 51800 are Nut Numbers
 1801 to 2000 and 51801 to 52000 are Roller Numbers
 2001 to 50000 and 52001 to 140000 and 142001 to 190000 are Sewing Machine Parts, 190001 and upward are numbers of Electrical Parts.

The figures in the second column refer only to the plates, illustrating the parts, and are NOT TO BE USED in ordering.

Parts marked with an asterisk (*) are furnished only when repairs are made at factory.

LIST OF PARTS COMPLETE FOR

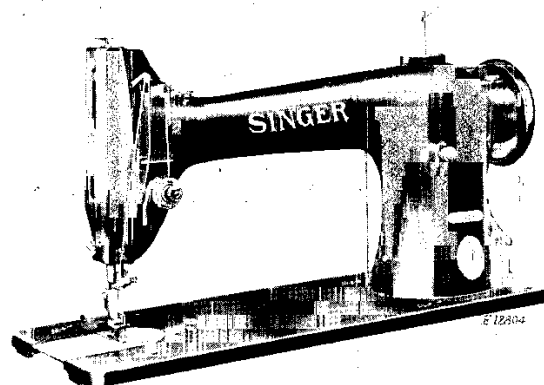

MACHINE No. 96-80

For Cloaks, Clothing and other Work in Cloth. Maximum stitch 5 1/2 to the inch. Drop feed. The machine is fitted with heavy gear shafts and three plain bearings for the arm shaft. The gears are lubricated with grease instead of oil. The grease is applied with Alemite Zerk hand pressure gun. Speed up to 4000 R. P. M., according to the material being stitched.

No.	Plate	Name
*127263	-----	Arm with 15404 and two each 15405 and 56015.....
16532	22217	Arm Dowel Pin.....
52182	22217	" Oil Tube with 52184, for oiling 127231
52183	22217	" " " " 52184, for oiling 52024 and 127156, for 127193 and 150460...
52180	22217	Arm Oil Tube (long) with 52184, for oiling 52022.....

Note: Due to the accuracy required for gear alignment, Arm cannot be supplied separately and can only be sent out as a unit, Arm and Bed assembled.

PARTS FOR MACHINE No. 96-80

No.	Plate	Name
52185	22217	Arm Oil Tube (short) with 42367, for oiling 52022.....
127187	22217	Arm Oil Tube (bent) with 42367, for oiling 127152, for 127193 and 150460...
56015	22217	Arm Oil Tube, for oiling 142006.....
52254	22217	" " " for oiling 52261.....
52184	22217	Arm Oil Tube Packing (wick) for 52180, 52182 and 52183.....
42367	22217	Arm Oil Tube Packing (braided cotton) for 52185 and 127187.....
52290	22217	Arm Oil Tube Hole Plug.....
116E	22217	" Screw (back).....
854E	22217	" " (front).....
127265	22223	" Shaft (horizontal).....
127266	-----	" " " 127265 with 52196 and 127253.....
66350	22218	Arm Shaft (horizontal) Back Bearing Oil Cup.....
127072	22219	Arm Shaft (horizontal) Bevel Gear with two 1036C.....
142003	22219	Arm Shaft (horizontal) Bevel Gear Case (two pieces) with 51068E, 140184E and 142005.....
142005	22217	Arm Shaft (horizontal) Bevel Gear Case Alemite Fitting.....
140184E	22217	Arm Shaft (horizontal) Bevel Gear Case Plug Screw.....
51068E	22218	Arm Shaft (horizontal) Bevel Gear Case Screw.....
1036C	22218	Arm Shaft (horizontal) Bevel Gear Set Screw.....
52259	-----	Arm Shaft (horizontal) Flanged Bushing (back).....
52260	22219	Arm Shaft (horizontal) Flanged Bushing (back) 52259 with 52193 and 52289...
52193	22218	Arm Shaft (horizontal) Flanged Bushing (back) Oil Pad (inside) braided cotton.....
52289	22218	Arm Shaft (horizontal) Flanged Bushing (back) Oil Pad (outside) felt.....
448C	22218	Arm Shaft (horizontal) Flanged Bushing (back) Set Screw.....
52195	-----	Arm Shaft (horizontal) Flanged Bushing (front).....
52196	22219	Arm Shaft (horizontal) Flanged Bushing (front) 52195 with 52193 and 52198..

PARTS FOR MACHINE No. 96-80

No.	Plate	Name
52193	22218	Arm Shaft (horizontal) Flanged Bushing (front) Oil Pad (inside) braided cotton.....
52198	22218	Arm Shaft (horizontal) Flanged Bushing (front) Oil Pad (outside) felt.....
435C	22218	Arm Shaft (horizontal) Flanged Bushing (front) Set Screw.....
66350	22218	Arm Shaft (horizontal) Front Bearing Oil Cup.....
52261	-----	Arm Shaft (horizontal) Intermediate Bushing.....
52262	22219	Arm Shaft (horizontal) Intermediate Bushing 52261 with 52193 and 52263..
52193	22218	Arm Shaft (horizontal) Intermediate Bushing Oil Pad (inside) braided cotton.....
52263	22218	Arm Shaft (horizontal) Intermediate Bushing Oil Pad (outside) felt.....
423C	22218	Arm Shaft (horizontal) Intermediate Bushing Set Screw.....
144D	22218	Arm Shaft (horizontal) Screw.....
142006	22219	" " (upright).....
52275	-----	" " " Bushing (lower).....
52276	22219	" " " " " 52275 with 52279 and 52280.....
432C	22218	Arm Shaft (upright) Bushing (lower) Set Screw.....
52277	-----	Arm Shaft (upright) Bushing (upper).....
52278	22219	" " " " " 52277 with 52279 and 52280.....
443C	22218	Arm Shaft (upright) Bushing (upper) Set Screw.....
52280	22218	Arm Shaft (upright) Bushing Oil Pad (outside) felt.....
52279	22218	Arm Shaft (upright) Bushing Oil Wick (inside) braided cotton.....
52281	22218	Arm Shaft (upright) Bevel Gear (lower) with two 1259C.....
1259C	22218	Arm Shaft (upright) Bevel Gear (lower) Set Screw.....
52282	22218	Arm Shaft (upright) Bevel Gear (upper) with two 1259C.....
1259C	22218	Arm Shaft (upright) Bevel Gear (upper) Set Screw.....
127146	21806	Arm Side Cap.....
219J	22218	" " " Screw.....
127079	22219	" " Cover.....
50053W	22218	" " " Thumb Screw.....

PARTS FOR MACHINE No. 96-80

No.	Plate	Name
52239	22218	Arm Spool Pin and Thread Eyelet.....
8879	5936	" " " Washer (cloth).....
127192	22219	" Top Cover.....
127193	22219	" " " 127192 with 52183, 52239, 127187 and 127255.....
127255	22218	Arm Top Cover Positioning Disc.....
158J	22218	" " " Screw.....
52176	22226	Balance Wheel (power, disc) 2-3/16 in. pulley, with two 448C.....
448C	22218	Balance Wheel Set Screw.....
*127270	-----	Bed.....
Note: Due to the accuracy required for gear alignment, Bed cannot be supplied separately and can only be sent out as a unit, Arm and Bed assembled.		
12431	-----	Bed Slide.....
4307	22220	" " " Spring.....
725J	22220	" " " Screw.....
12432	21806	Bed Slide complete, Nos. 4307, 12431 and two 725J.....
52051	22226	Face Plate.....
176J	22220	" " " Screw.....
52053	22220	" " " Thread Guard (lower).....
226J	22220	" " " " " Screw....
52170	22220	" " " " " (upper).....
226J	22220	" " " " " Screw....
52052	-----	Face Plate complete, Nos. 52051, 52053, 52170 and two 226J.....
50190W	22220	Face Plate Thumb Screw.....
52452	22219	Feed Bar.....
313C	22220	" " " Screw Center.....
56813	-----	" " " " " 313C with 1519J...
1519J	22220	" " " " " Nut.....
52165	22220	" " " " " Connecting Link.....
375C	22220	" " " " " Hinge Screw.....
1518J	22220	" " " " " " Nut....
52073	22220	" " " " " Stud.....
50083C	22220	" " " " " Set Screw
127087	7727	" " " " " Dog, 19 teeth (16 teeth to the inch) for 127106 and 127107.....
50117E	22220	Feed Dog Screw.....
127202	22219	" and Feed Lifting Eccentric with 448C, 1299C, 52210 and 52211.....
127225	-----	Feed and Feed Lifting Eccentric 127202 with 127152.....
52210	22220	Feed and Feed Lifting Eccentric Lubri- cating Pad (long) wood.....
52211	22220	Feed and Feed Lifting Eccentric Lubri- cating Pad (short) wood.....

PARTS FOR MACHINE No. 96-80

No.	Plate	Name
1299C	22220	Feed and Feed Lifting Eccentric Position Screw.....
448C	22218	Feed and Feed Lifting Eccentric Set Screw.....
127152	22219	Feed and Feed Lifting Eccentric Sleeve..
20284	22223	" Forked Connection.....
52393	-----	" " " " 20284 with 375C, 1518J and 52165.....
375C	22220	Feed Forked Connection Hinge Screw.....
1518J	22220	" " " " " Nut..
52384	22223	" " Lifting Rock Shaft.....
127269	-----	Feed Lifting Rock Shaft complete, Nos. 52265 and 52384.....
127156	22223	Feed Lifting Rock Shaft Connecting Rod with two 966E.....
966E	22220	Feed Lifting Rock Shaft Connecting Rod Cap Screw.....
375C	22220	Feed Lifting Rock Shaft Connecting Rod Hinge Screw.....
1518J	22220	Feed Lifting Rock Shaft Connecting Rod Hinge Screw Nut.....
*52271	-----	Feed Lifting Rock Shaft Crank.....
52265	22219	" " " " " " 52271 with 157J and 52267.....
157J	22220	Feed Lifting Rock Shaft Crank Clamping Screw.....
52266	-----	Feed Lifting Rock Shaft Crank Slide Block.....
52267	22220	Feed Lifting Rock Shaft Crank Slide Block 52266 with 125060.....
*125060	-----	Feed Lifting Rock Shaft Crank Slide Block Stud.....
50191C	22220	Feed Lifting Rock Shaft Screw Center....
52097	-----	" " " " " " 50191C with 1513J.....
1513J	22222	Feed Lifting Rock Shaft Screw Center Nut
52074	22221	" Regulator with 50083C.....
52118	-----	" " " 52074 with 52073.....
52093	-----	" " " 52118 with 818W.....
1128E	22222	" " " Hinge Screw.....
818W	22222	" " " Thumb Screw.....
52386	22223	" " " Rock Shaft.....
29633	22222	" " " Crank with 157J.....
157J	22220	" " " " " Clamping Screw....
52387	-----	Feed Rock Shaft complete, Nos. 29633 and 52386.....
50191C	22220	Feed Rock Shaft Screw Center.....
52097	-----	" " " " " " 50191C with 1513J.....

PARTS FOR MACHINE No. 96-80

No.	Plate	Name
1513J	22222	Feed Rock Shaft Screw Center Nut.....
25866	22221	Guide.....
50190W	22220	" Thumb Screw.....
127088	22221	Needle Bar (hollow).....
127116	-----	" " 127088 with 229J, 52306 and 52307.....
127230	22222	Needle Bar Bushing (lower).....
1133E	22222	" " " Set Screw.....
52014	22221	" " " (upper).....
1133E	22222	" " " Set Screw.....
127231	22222	" " Connecting Link with 52207....
127232	-----	" " " 127231 with 24041.....
775E	22222	Needle Bar Connecting Link Cap Screw....
52207	22222	" " " Lubricating Pad (wood).....
24041	22222	Needle Bar Connecting Stud with 207E....
207E	2834	" " " Clamping Screw
127253	22221	" " Crank with 1036C, 1037C and 1065C.....
1065C	22222	Needle Bar Crank Position Screw.....
52306	22222	" " Thread Guard.....
229J	22222	" " " Screw.....
52307	22222	" Clamp with 51460F.....
51460F	22222	" Screw.....
127191	22221	Oil Tube with 52184.....
127091	22221	" " Bracket.....
127092	22221	" " 127091 with 127191, for oiling 52185.....
52184	22217	Oil Tube Packing (wick).....
12391	22221	Presser Bar (hollow).....
52338	5936	" " Guide Bracket with 223C and 453C.....
453C	5936	Presser Bar Guide Bracket Set Screw.....
52016	5936	" " Lifter.....
689C	5936	" " " Hinge Screw.....
1520J	5936	" " " Nut.....
12327	5936	" " Lifting and Releasing Lever Bracket.....
127108	22221	Presser Bar Spring.....
11170	5936	" " " Washer.....
7298	7726	" Foot Hinge Pin.....
19334	-----	" Plate.....
19335	-----	" Shank.....
19336	7726	Presser Foot (hinged) complete, Nos. 7298 19334 and 19335.....
176J	22220	Presser Foot Screw.....
689W	7726	Pressure Regulating Thumb Screw.....
127095	22222	Rotating Hook with three 1253C.....

PARTS FOR MACHINE No. 96-80

No.	Plate	Name
127096	-----	Rotating Hook-127095 with 127102 and four 1053E.....
*127239	-----	Rotating Hook 127096 with 40274, 127242 and three 1367E.....
127097	-----	Rotating Hook 127096 with 40274 and three 1367E (For agents only).....
127240	-----	Rotating Hook 127239 with 52237.....
40264	22222	" " Bobbin.....
52235	-----	" " " Case.....
52236	-----	" " " 52235 with 591F 1380E and 40394.....
40392	22222	Rotating Hook Bobbin Case Latch.....
125320	22222	" " " " Lever....
2974	22224	" " " " " "
		Fulcrum Pin.....
2975	22222	Rotating Hook Bobbin Case Latch Spring..
592E	22224	" " " " Stop Screw
40393	-----	" " " " Hinge, Nos. 2974, 40392 and 125320.....
591F	22224	Rotating Hook Bobbin Case Tension Regu- lating Screw.....
40394	22222	Rotating Hook Bobbin Case Tension Spring
1380E	22224	" " " " " "
		Screw.....
52237	22224	Rotating Hook Bobbin Case complete, Nos. 592E, 2975, 40393 and 52236.....
127241	-----	Rotating Hook Bobbin Case 52237 with 127242.....
127242	22224	Rotating Hook Bobbin Case Holder.....
52018	22224	" " " " " Position Bracket.....
704J	22224	Rotating Hook Bobbin Case Holder Posi- tion Bracket Screw.....
40274	22224	Rotating Hook Section.....
1367E	22224	" " " Screw.....
1253C	22224	" " Set Screw.....
127292	22223	" " Shaft.....
127073	22224	" " " Bevel Gear with two 1259C.....
142004	22221	Rotating Hook Shaft Bevel Gear Case (two pieces) with 51068E, 140184E and 142005.....
142005	22217	Rotating Hook Shaft Bevel Gear Case Alemite Fitting.....
140184E	22217	Rotating Hook Shaft Bevel Gear Case Plug Screw.....
51068E	22218	Rotating Hook Shaft Bevel Gear Case Screw.....
1259C	22218	Rotating Hook Shaft Bevel Gear Set Screw

No.	Plate	Name
52285	-----	Rotating Hook Shaft Bushing (back).....
52286	22221	" " " " " " 52285
		with 52279 and 52280.....
1148C	22224	Rotating Hook Shaft Bushing (back) Set Screw.....
52287	-----	Rotating Hook Shaft Bushing (front).....
52288	22221	" " " " " " 52287
		with 52279 and 52280.....
142008	22224	Rotating Hook Shaft Bushing (front) Oil Cup.....
1148C	22224	Rotating Hook Shaft Bushing (front) Set Screw.....
52280	22218	Rotating Hook Shaft Bushing Oil Pad (outside) felt.....
52279	22218	Rotating Hook Shaft Bushing Oil Wick (inside) braided cotton.....
127102	22224	Rotating Hook Thread Guard.....
1053E	22224	" " " " " " Screw.....
52337	5936	Slack Thread Regulator.....
223C	5936	" " " " " " Set Screw.....
2102	3471	Tension Disc.....
1560C	22224	" " " " " " Regulating Thumb Nut.....
32572	7726	" " " " " " Releasing Disc.....
43944	5936	" " " " " " Lever.....
12398	5936	" " " " " " Hinge Pin.....
12329	5936	" " " " " " Spring.....
32574	7726	" " " " " " Pin.....
2103	7726	" " " " " " Spring.....
50304C	7726	" " " " " " Stud.....
52098	-----	" " " " " " 50304C with 1560C.....
50305C	22224	" " " " " " Set Screw.....
52397	-----	Tension complete, Nos. 2103, 32572, 32574, 52083, 52098, 52394 and two 2102....
52027	7726	Thread Guard (side of arm).....
52454	22224	" " " " " " Retainer.....
624C	22224	" " " " " " Set Screw.....
52269	-----	Thread Take-up complete, Nos. 11204, 52025 and 52270.....
52216	22224	Thread Take-up Crank.....
52270	-----	" " " " " " 52216 with 775E and 127232.....
1037C	22225	Thread Take-up Crank Position Screw.....
1036C	22218	" " " " " " Set Screw.....
52022	22225	" " " " " " Lever with 52130.....
52023	22225	" " " " " " Hinge Pin.....
52024	22225	" " " " " " Link.....
11204	22225	" " " " " " Hinge Pin.....
435C	22218	" " " " " " " " " " " " Set Screw.....

No.	Plate	Name
52130	22225	Thread Take-up Lever Thread Eyelet Bushing.....
52025	-----	Thread Take-up Lever complete, Nos. 52022 to 52024.....
52394	7726	Thread Take-up Spring.....
52083	7726	" " " " " " Regulator with 50305C.....
448C	22218	Thread Take-up Spring Regulator Set Screw.....
127106	7727	Throat Plate, large needle hole, for 127087.....
127107	-----	Throat Plate, small needle hole, for 127087.....

Note: Throat Plate No. 127106 is sent with this machine, unless otherwise stated on order.

691F	7727	Throat Plate Screw.....
44212	7734	Drip Pan with four 1 in. wire nails.....
*15404	-----	Trade Mark.....
15405	-----	" " " " " " Rivet.....

Genuine Singer Needles should be used in Singer Machines. These Needles and their Containers are marked with the Company's Trade Mark "SIMANCO." 1

Needles in Containers marked "For Singer Machines" are not Singer made needles. 2

MACHINE No. 96-86

For Cloaks, Clothing and other Work in Cloth. Maximum stitch seven. to the inch. Drop feed. The machine is fitted with heavy gear shafts and three plain bearings for the arm shaft. The gears are lubricated with grease instead of oil. The grease is applied with Alemite Zerk hand pressure gun. Speed up to 4000 R. P. M., according to the material being stitched.

NOTE: THIS MACHINE IS THE SAME AS THE 96-80 MACHINE, WITH THE FOLLOWING EXCEPTIONS:

No.	Plate	Name
127284	-----	Arm Shaft (horizontal) 127265 with 52196 and 52246, in place of 127266.....
52462	7727	Feed Dog, 19 teeth (22 teeth to the inch) for 52463, in place of 127087.
52246	22221	Needle Bar Crank with 1036C, 1037C and 1065C, in place of 127253.....
62527	22225	Presser Foot Hinge Pin, in place of 7298
24544	-----	" " Plate, in place of 19334...
24982	-----	" " Shank, in place of 19335...
26231	7726	" " Spring.....
24983	7726	Presser Foot (spring hinged) complete, Nos. 24544, 24982, 26231 and 62527, in place of 19336.....
52463	7727	Throat Plate for 52462, in place of 127106 and 127107.....

MACHINE No. 96-100

For Cloaks, Clothing and other Work in Cloth. Maximum stitch 5 1/2 to the inch. Drop feed. The machine is fitted with heavy gear shafts; a plain bushed intermediate bearing, also front and rear ball bearings for the arm shaft. The gears are lubricated with grease instead of oil. The grease is applied with Alemite Zerk hand pressure gun. Speed up to 4000 R. P. M., according to the material being stitched.

NOTE: THIS MACHINE IS THE SAME AS THE 96-80 MACHINE, WITH THE FOLLOWING EXCEPTIONS:

No.	Plate	Name
*127264	-----	Arm with 15404 and two each 15405 and 56015, in place of 127263.....
Note: Due to the accuracy required for gear alignment, Arm cannot be supplied separately and can only be sent out as a unit, Arm and Bed assembled.		
127267	22223	Arm Shaft (horizontal) with 127067, in place of 127265.....
127268	-----	Arm Shaft (horizontal) 127267 with 127199, in place of 127266.....
54897	22225	Arm Shaft (horizontal) Back Bearing Oil Cup, in place of 66350.....
52146	22225	Arm Shaft (horizontal) Back Bearing Oil Cup Pad (braided cotton).....
127011	22221	Arm Shaft (horizontal) Ball Bearing (back) in place of 52260.....
*127143	-----	Arm Shaft (horizontal) Ball Bearing (back) Cover.....
127144	22221	Arm Shaft (horizontal) Ball Bearing (back) Cover 127143 with 127145.....
*127145	-----	Arm Shaft (horizontal) Ball Bearing (back) Cover Oil Lead.....
219J	22218	Arm Shaft (horizontal) Ball Bearing (back) Cover Screw.....
52486	22225	Arm Shaft (horizontal) Ball Bearing (back) Locking Pin.....
52487	22225	Arm Shaft (horizontal) Ball Bearing (back) Locking Pin Cone.....

No.	Plate	Name
446C	22225	Arm Shaft (horizontal) Ball Bearing (back) Locking Pin Cone Screw.....
127066	22221	Arm Shaft (horizontal) Ball Bearing (front) in place of 52196.....
127009	22221	Arm Shaft (horizontal) Ball Bearing (front) Cover.....
401E	22225	Arm Shaft (horizontal) Ball Bearing (front) Cover Screw.....
127067	22225	Arm Shaft (horizontal) Ball Bearing (front) Key.....
54897	22225	Arm Shaft (horizontal) Front Bearing Oil Cup, in place of 68350.....
52146	22225	Arm Shaft (horizontal) Front Bearing Oil Pad (braided cotton).....
127254	22221	Needle Bar Crank with 1036C, 1037C and 1065C.....
127199	-----	Needle Bar Crank 127254 with 401E and 127009, in place of 127253.....

Genuine Singer Needles should be used in Singer Machines. These Needles and their Containers are marked with the Company's Trade Mark "SIMANCO." 1

Needles in Containers marked "For Singer Machines" are not Singer made needles. 2

MACHINE-BASE

No.	Plate	Name
19219	22225	Bed Frame Cushion (leather).....
158C	22218	" " " Screw.....
19220	7730	" " " Spring.....
19226	7730	" " Hinge Connection.....
19398	-----	" " " " 19226 with 211E and 19397.....
19397	22225	Bed Frame Hinge Connection Cap.....
211E	22225	" " " " " Screw....
16555	7730	" " " Plate.....
14010	22225	" " " Rivet.....
20067	819	" " with two each 16555, 19398, four each 19219, 19220, six each 14010, wood screws 1-1/4 in. No. 12 F.H. and eight 158C.....

ACCESSORIES

No.	Plate	Name
121587	22223	Grease Gun (3 oz. capacity) for Fitting No. 142005.....
121588	-----	Grease Gun (1/2 lb.capacity) for Fitting No. 142005.....
20022	22225	Machine Cushion (felt).....
27878	22225	" " Rivet.....
12361	7730	" Hinge Connection.....
44139	7730	" " Plate.....
44140	-----	Machine Hinge complete, Nos. 12361, 44139 and merlized wood screw 1-1/4 in.No. 14 F.H.....
41400	22226	Machine Rest Pin (wood).....
120342	21835	Oiler (copper plated) with 120343.....
120343	21835	" Spout, 3-1/2 in. long.....
26026	21835	Screw Driver (large).....
26485	21835	" " (small).....
8909	21835	Wrench for 1513 and 1518.....
8908	21835	" " 1519 and 1520.....

BOBBIN WINDERS

BOBBIN WINDER

(SWINGING AUTOMATIC, LEFT HAND)

No.	Plate	Name
41913	21834	Bracket with 457C.....
41563	21834	Frame with 457C.....
34105	21834	" Hinge Pin.....
457C	22225	" " " Set Screw.....
41914	21834	" Spring.....
41585	21834	Pulley with 171J.....
171J	22225	" Set Screw.....
41586	21834	Spindle.....
41587	21834	Stop Latch.....
42614	21834	" " Hinge Stud.....
457C	22225	" " " Set Screw.....
7958	22225	" " Stop Pin.....
41588	21834	" Tripping Arm with 185H.....
185H	22225	" " " Clamping Screw..
150459	21834	Tension Bracket with 460C.....
150460	-----	Tension Bracket complete, Nos. 41593 to 41595, 52183, 52239, 127187, 127255, 150459 and two 2455.....
127255	22218	Tension Bracket Positioning Disc.....
158J	22218	" " Screw.....
52239	22218	" " Spool Pin and Thread Eyelet.....
8879	5936	Tension Bracket Spool Pin Washer (cloth)
2455	22227	" Disc.....
41593	5936	" Spring.....
41594	5936	" Stud.....
460C	22227	" Set Screw.....
41595	5936	" Thread Guide.....
60845	-----	Bobbin Winder, Nos. 7958, 34105, 41583, 41585 to 41588, 41913, 41914 and 42614.....
41915	21834	Bobbin Winder 60845 with 880E and 25446.
150461	-----	Bobbin Winder complete, Nos. 41915 and 150460.....
880E	22227	Bobbin Winder Screw.....
25446	22227	" " Washer.....

BOBBIN WINDER

(SWINGING AUTOMATIC, RIGHT HAND)

No.	Plate	Name
41339	2833	Base.....
41340	2833	Frame.....
1429D	2834	" Hinge Screw.....
41341	2833	" Spring.....
207J	2834	" " Screw.....
41342	2833	Pulley with 200F.....
200F	2834	" Set Screw.....
41343	2834	Spindle.....
27306	2834	Spool Pin.....
27307	2833	" Stand.....
27308	2833	Spool Stand complete, Nos. 418E, 1562J, 2106, 10141, 11241, 27306, 27307 and two each 2455 and wood screws 1 in. No. 10 F.H.....
11241	2833	Spool Washer (cloth).....
41344	2834	Stop Latch.....
41345	2834	" " Finger.....
152F	2834	" " " Screw.....
1430D	2834	" " Hinge Screw.....
1550H	2834	" " " Nut.....
41346	2834	" " Lever.....
1430D	2834	" " " Hinge Screw.....
2455	22227	Tension Disc.....
1562J	2834	" " Regulating Thumb Nut.....
418E	2834	" " Screw Stud.....
10141	2834	" Spring.....
2106	2834	" Thread Guide.....
60456	-----	Bobbin Winder, Nos. 152F, 207J, 1429D, 1550H, 41339 to 41346 and three 1430D.....
41347	2833	Bobbin Winder, Nos. 60456 and two each 9331 and wood screws 1 in. No. 10 R.H.....
41348	-----	Bobbin Winder complete, Nos. 27308 and 41347.....
9331	2834	Bobbin Winder Washer.....

BOBBIN WINDER
(SWINGING AUTOMATIC, RIGHT HAND)

FOR POWER TABLE

No.	Plate	Name
225433	3469	Bobbin Winder and Tension Bracket Base..
225453	3470	Frame with 202277 and 225438.....
225454	3471	" Hinge Pin.....
202277	3471	" Oil Packing (wick).....
225438	3471	" Well Cap.....
225455	3471	" Spring.....
225456	3471	" " Plunger.....
202473	3470	Pulley with 200380C.....
200380C	3471	" Set Screw.....
225381	3470	Spindle.....
225444	3471	Stop Latch.....
200056E	3471	" " Screw.....
225458	3471	" " Thumb Lever.....
225459	3471	" " " Hinge Stud.....
225459	3471	" " " Joint Stud.....
202478	3471	" " Trip Lever.....
200299H	3471	" " " Hinge Screw.....
225461	3471	Tension Bracket with 201499B.....
200082D	3471	" " Screw.....
228026	-----	" " Washer.....
2102	3471	" Disc.....
202407	3471	" Spring.....
201499B	3471	" Stud.....
201572B	3471	" " Thumb Nut.....
225462	-----	Tension Bracket complete, Nos. 201572B, 202407, 225461 and two 2102.....
225382	3469	Bobbin Winder complete, Nos. 200056E, 200082D, 200299H, 202473, 202478, 225381, 225433, 225444, 225453 to 225456, 225458, 225462, 228026, two each 225459 and wood screws 3/4 in. No.12 R.H.....

BINDER ON SHANK

No.	Plate	Name
35208	1971	Binder on Shank, to turn in both edges, for bias or straight binding, for skirts, wrappers, shirt waists, etc.
26603	21818	Feed Dog, 20 teeth (16 teeth to the inch) for 26605, 26606 and 35208....
52055	21819	Presser Foot.....
26605	21818	Throat Plate, large needle hole, for 26603.....
26606	-----	Throat Plate, small needle hole, for 26603.....

BINDER (Transverse) ON SHANK

FOR FOLDED OR UNFOLDED BIAS BINDING
(WITH TAPE REEL) FOR GENERAL WORK

No.	Plate	Name
121167	22227	Binder Folder on Shank.....
43525	21818	" Steady Pin.....
51097J	22227	" Thumb Screw.....
3146	22227	" " Washer.....
121397	21818	Feed Dog, 18 teeth (16 teeth to the inch) for 121168 and 121398.....
121169	21819	Presser Foot.....
121412	21819	Tape Reel Arm with 8879,11656 and 120537
11656	21819	" " Steady Pin.....
51097J	22227	" " Thumb Screw.....
120536	22226	" " Disc with 120538 and 120539...
120537	-----	" " Pin.....
120538	-----	" " Stud (wood).....
120539	-----	" " Sleeve.....
8879	5936	" " Washer (cloth).....
121398	21818	Throat Plate with 43525, for 121168 and 121397.....
121168	-----	Binder (transverse) on Shank complete, for 3/4 in., 7/8 in. and 1 in. tape, Nos. 3146, 120536, 121167, 121169, 121397, 121398,121412 and two 51097J

FINGER GUARDS

No.	Plate	Name
121326	22227	Finger Guard.....
36619	22227	" " Friction Washer.....
36620	22227	" " Holder with 196J.....
196J	22227	" " Set Screw.....
50316J	22227	" " Screw.....
121327	22227	Finger Guard (metal) complete, Nos. 36619 36620, 50316J and 121326.....
120857	22227	Finger Guard.....
120858	22227	" " Holder with 50302J.....
50302J	22227	" " Set Screw.....
236J	22227	" " Screw.....
120860	22227	Finger Guard (wire) complete, Nos. 120857 120858 and two 236J.....

HEMMERS (Foot)

No.	Plate	Name
120938	5921	Hemmer (foot) for 3/32 in. hem.....
120803	5919	" " " 1/8 in. hem.....
120804	5919	" " " 5/32 in. hem.....
120805	5919	" " " 3/16 in. hem.....
36122	-----	" " " 7/32 in. hem.....
120806	5920	" " " 1/4 in. hem.....
120807	5920	" " " 5/16 in. hem.....
6267	-----	" Folder, for 36122.....
120939	5920	" " " 120803 to 120807 and 120938.....
*25888	-----	Hemmer Tongue, for 36122.....
*120838	5920	" " " 120804 and 120805.....
*120839	5920	" " " 120806 and 120807.....
*120843	5919	" " " 120803 and 120938.....

Note: When ordering Hemmer Folders or Hemmer Tongues, state width of hem and No. of hemmer for which they are required.

35710	-----	Hemmer (foot) 3/32 in. hem, with guide on bottom to the right of needle hole..
35682	21817	Hemmer (foot) 1/8 in. hem, with guide on bottom to the right of needle hole..
36524	-----	Hemmer (foot) 5/32 in. hem, with guide on bottom to the right of needle hole..
35997	-----	Hemmer (foot) 3/16 in. hem, with guide on bottom to the right of needle hole..
36309	-----	Hemmer (foot) 7/32 in. hem, with guide on bottom to the right of needle hole..
36072	-----	Hemmer (foot) 1/4 in. hem, with guide on bottom to the right of needle hole..
120898	5921	Hemmer (foot) for 1/16 in. to 1/8 in. hem for China Silk, etc.....

No.	Plate	Name
120911	5921	Hemmer (foot) for 5/32 in. to 1/4 in. hem for China Silk, etc.....
36413	-----	Hemmer (foot) plain bottom, for 1/16 in. hem.....
36414	-----	Hemmer (foot) plain bottom, for 3/32 in. hem.....
36480	-----	Hemmer (foot) plain bottom, for 5/32 in. hem.....
36416	-----	Hemmer (foot) plain bottom, for 3/16 in. hem.....
120837	5920	Hemmer (foot) plain bottom, for 1/8 in. hem, slotted for lace.....

HEMMERS ON SHANK

No.	Plate	Name
35926	-----	Hemmer.....
590J	22227	" Adjusting Screw.....
1443B	22227	" Screw.....
35927	-----	" Shank.....
35540	5882	Hemmer on Shank (adjustable) complete, with right hand lower guide for lace, Nos. 1443B, 35926, 35927 and two 590J.....
20163	5882	Feed Dog, for 1/16 in. stitch, 16 teeth (16 teeth to the inch) for 20123, for 35540.....
62527	22225	Presser Foot Hinge Pin.....
40316	-----	" " Plate.....
40317	-----	" " Shank.....
40318	5882	Presser Foot (hinged) complete, for lace running, for 35540, Nos. 40316, 40317 and 62527.....
20123	5882	Throat Plate for 20163, for 35540.....
35236	1971	Hemmer on Shank, for 7/16 in. hem and above, for bottom of shirt waists...
26603	21818	Feed Dog, 20 teeth (16 teeth to the inch) for 26605 and 26606, for 35236
52055	21819	Presser Foot, for 35236.....
26605	21818	Throat Plate, large needle hole, for 26603.....
26606	-----	Throat Plate, small needle hole, for 26603.....

PIPING ATTACHMENT

No.	Plate	Name
120977	-----	Piping Attachment.....
1443J	22227	" " " Screw.....
35245	21817	Piping Attachment complete, for piping house dresses, Nos. 1443J and 120977
44253	22228	Feed Dog, 16 teeth (16 teeth to the inch) for 44255 and 44256.....
52056	21817	Presser Foot.....
44256	22228	Throat Plate, large needle hole, for 44253.....
44255	-----	Throat Plate, small needle hole, for 44253.....

PRESSER FEET

No.	Plate	Name
36464	21817	Presser Foot Spring Guide.....
665J	21817	" " " " Screw.....
36465	21817	Presser Foot (right hand spring guide) with 665J and 36464, for 1/32 in. to 5/16 in. gauges.....
Note: When ordering No. 36464 or No. 36465, state required distance from edge of goods to seam.		
36574	22228	Presser Foot.....
36575	-----	" " " 36574 with 36576 and two 50202J.....
36576	22228	Presser Foot Finger Guard.....
50202J	22228	" " " " Screw.....
36714	-----	" " " with 233J.....
36715	21817	" " " Guide (right) with 36716...
233J	21817	" " " Set Screw.....
36716	21817	" " " Stud.....
36717	21817	Presser Foot complete with Adjustable Guide (right) Nos. 36714 and 36715..
36773	21819	Presser Foot, for braiding.....
120828	21817	" " (single toe) for gathering, for fine work.....

RUFFLER

No.	Plate	Name
121116	22229	Driving Lever.....
51371K	22227	" " Adjusting Thumb Screw (lower)

RUFFLER

No.	Plate	Name
560B	22227	Driving Lever Adjusting Thumb Screw (upper).....
120812	22228	Driving Lever Bushing.....
120813	22228	" " Friction Washer.....
51219F	22227	" " Hinge Screw.....
1700J	22228	" " " " Nut.....
121117	22229	Frame.....
36637	22228	" Spring Plate.....
36638	22228	Ribbon Guide.....
240B	22228	" " Screw.....
121118	22228	Ruffling Blade.....
121119	22228	" " Holder.....
121120	-----	" " " 121119 with 121118 and two 120829.....
36641	22228	Ruffling Blade Holder Guide.....
36642	22228	" " " Rivet.....
51221F	22228	" " " Hinge Screw.....
1772J	22228	" " " Nut...
121121	22229	" " Lever with 560B and 51371K.....
120829	22228	Ruffling Blade Rivet.....
36644	22228	Separating Blade.....
120830	-----	" " Holder.....
121501	-----	" " " 120830 with 36644 and two 120829.....
36646	22228	Separating Blade Holder Friction Spring.
36647	22228	" " " Hinge Stud.....
36648	22228	" " " Stop Stud.....
120829	22228	" " Rivet.....
36644	22228	Shirring Blade.....
120818	-----	" " Holder.....
120819	-----	" " " 120818 with 36644 and two 120829.....
120829	22228	Shirring Blade Rivet.....
121123	22229	Ruffler complete, Nos. 240B, 1700J, 1772J 36637, 36638, 36641, 36642, 36646 to 36648, 51219F, 51221F, 120812, 120813 121116, 121117, 121120, 121121 and 121501.....
121452	-----	Ruffler 121123 with 120819 and 120875...
120875	22227	Needle Clamp with 50203F.....
50203F	22227	" " Screw.....

FOOT LIFTER PARTS

No.	Plate	Name
5596	22226	Bell Crank.....

FOOT LIFTER PARTS

No.	Plate	Name
56848	-----	Bell Crank 5596 with 5599 and 5601.....
5599	22226	" " Bracket.....
178E	22230	" " " Screw.....
5601	22230	" " Hinge Pin.....
5735	7730	" " Spring.....
5598	22226	Bell Crank complete, Nos. 5735 and 56848
5670	-----	Chain, length 26 in. to 35 in., with 56864 and 56865.....
Note: When ordering No. 5670, state length re- quired.		
56864	7730	Chain Hook (large).....
56865	7730	" " (small).....
4879	7730	" Connecting Link.....
12237	22223	Lifting Lever with 448C.....
52028	22226	" " Connecting Rod.....
12416	5936	" " " " Joint.....
76D	22230	" " " " " Hinge Screw.....
1521E	22230	Lifting Lever Connecting Rod Lock Nut...
802D	22230	" " Hinge Screw.....
12241	5936	" " Link.....
766D	22230	" " " Hinge Screw.....
12240	22230	" " Pin.....
448C	22218	" " " Set Screw.....
2763	819	Rock Shaft.....
12242	819	" " Hanger with two wood screws 1 in. No. 10 F.H.....
6337	819	Rock Shaft Lifting Bracket with two 356C
12243	819	" " " Hook.....
7125	819	" " " " Hook.....
356C	22230	" " " " Set Screw
356C	22230	" " " " Set Screw....
2770	819	" " Stop Dog with 356C.....
356C	22230	" " " " Set Screw.....
4880	819	Rock Shaft complete, Nos. 2763, 2770, 7125, 12243 and two each 6337 and 12242.....
4881	819	Treadle.....
4882	22230	" Shaft.....
4883	22230	" Spring.....
4884	819	" Stand.....
4885	819	Treadle complete, Nos. 4879, 4881 to 4884 and two wood screws 1 in. No.16 F.H.....
52319	-----	Foot Lifter complete, Nos. 76D, 766D, 802D, 1521E, 4880, 4885, 5598, 5670, 12237, 12240, 12241, 12416, 52028 and two 178E.....

KNEE LIFTER PARTS

No.	Plate	Name
5596	22226	Bell Crank.....
56848	-----	" " 5596 with 5599 and 5601.....
5599	22226	" " Bracket.....
178E	22230	" " " Screw.....
5601	22230	" " Hinge Pin.....
5735	7730	" " Spring.....
5598	22226	Bell Crank complete, Nos. 5735 and 56848.
12237	22223	Lifting Lever with 448C.....
52028	22226	" " Connecting Rod.....
12416	5936	" " " " Joint.....
76D	22230	" " " " " Hinge Screw.....
1521E	22230	Lifting Lever Connecting Rod Lock Nut...
802D	22230	" " Hinge Screw.....
12241	5936	" " Link.....
766D	22230	" " " Hinge Screw.....
12240	22230	" " Pin.....
448C	22218	" " " Set Screw.....
2763	21823	Rock Shaft.....
7539	21823	" " Hanger with two wood screws 1 in. No. 10 F.H.....
2765	21823	Rock Shaft Knee Arm.....
2766	21823	" " " " Hub with 356C.....
356C	22230	" " " " " Set Screw.....
2768	-----	Rock Shaft Knee Arm complete, Nos. 2765 to 2767.....
2767	21823	Rock Shaft Knee Plate with 356C.....
356C	22230	" " " " Set Screw.....
6337	21823	" " Lifting Bracket with two 356C
2778	21823	" " " Hook.....
356C	22230	" " " " Set Screw
356C	22230	" " " " Set Screw....
2770	21823	" " Stop Dog with 356C.....
356C	22230	" " " " Set Screw.....
12250	21823	Rock Shaft complete, Nos. 2763, 2768, 2778, 6337 and two each 2770 and 7539.....
52320	-----	Knee Lifter complete (power table) Nos. 76D, 766D, 802D, 1521E, 5598, 12237, 12240, 12241, 12250, 12416, 52028 and two 178E.....

THREAD UNWINDER

(FOR TWO SPOOLS OR TWO LARGE CONES OF THREAD)

No.	Plate	Name
225257	20335	Spool Rest with 201018C.....
150203	20335	" " Cushion (felt).....
225388	20335	" " Rod.....
200383C	22230	" " Set Screw.....
201018C	22230	" " Set Screw.....
202490	20335	" Stand with 200383C.....
225391	20335	Thread Guide.....
201696J	22230	" " Lock Nut.....
225326	20335	" " Position Cup.....
225324	20335	" " Rod with 208E and 225322....
208E	22230	" " Screw.....
225322	22230	" " Washer.....
225258	20335	Thread Unwinder complete, Nos. 201696J, 202490, 225257, 225324, 225326, 225388, two each 150203, 225391 and three wood screws 7/8 in. No. 12 F.H.
27739	7234	Thread Cone (wood) for large cones.....
225390	7234	" " Holder, for inverted cones..

Note: Nos. 27739 and 225390 are used with, but not included in 225258.

Genuine Singer Needles should be used
in Singer Machines.
These Needles and their Containers
are marked with the
Company's Trade Mark "SIMANCO." 1

Needles in Containers marked
"For Singer Machines"
are not Singer made needles. 2

NUMERICAL LIST OF PARTS

No.	Plate	Name
76D	22230	Lifting Lever Connecting Rod Joint Hinge Screw, for 52319 and 52320.....
116E	22217	Arm Screw (back).....
144D	22218	" Shaft (horizontal) Screw.....
152F	2834	Bobbin Winder Stop Latch Finger Screw, for 60456.....
157J	22220	Feed Lifting Rock Shaft Crank Clamping Screw, for 52265.....
157J	22220	Feed Rock Shaft Crank Clamping Screw, for 29633.....
158J	22218	Arm Top Cover Screw.....
158C	22218	Bed Frame Cushion Screw, for 20067.....
158J	22218	Bobbin Winder Tension Bracket Screw, for 150461.....
171J	22225	Bobbin Winder Pulley Set Screw, for 41585
176J	22220	Face Plate Screw.....
176J	22220	Presser Foot Screw.....
178E	22230	Bell Crank Bracket Screw, for 52319 and 52320.....
185H	22225	Bobbin Winder Stop Latch Tripping Arm Clamping Screw, for 41588.....
196J	22227	Finger Guard Holder Set Screw, for 36820
200F	2834	Bobbin Winder Pulley Set Screw, for 41342
207E	2834	Needle Bar Connecting Stud Clamping Screw, for 24041.....
207J	2834	Bobbin Winder Frame Spring Screw, for 60456.....
208E	22230	Thread Unwinder Thread Guide Rod Screw, for 225324.....
211E	22225	Bed Frame Hinge Connection Cap Screw, for 19398.....
219J	22218	Arm Shaft (horizontal) Ball Bearing (back) Cover Screw, for 96-100 Ma- chine.....
219J	22218	Arm Side Cap Screw.....
223C	5936	Slack Thread Regulator Set Screw, for 52338.....
226J	22220	Face Plate Thread Guard (lower) Screw, for 52052.....
226J	22220	Face Plate Thread Guard (upper) Screw, for 52052.....
229J	22222	Needle Bar Thread Guard Screw, for 127116
233J	21317	Presser Foot Guide Set Screw, for 36714.

NUMERICAL LIST OF PARTS

No.	Plate	Name
236J	22227	Finger Guard Screw, for 120860.....
240B	22228	Ruffler Ribbon Guide Screw, for 121123..
313C	22220	Feed Bar Screw Center, for 56813.....
356C	22230	Rock Shaft Lifting Bracket Hook Set Screw, for 6337.....
356C	22230	Rock Shaft Lifting Bracket Set Screw, for 6337.....
356C	22230	Rock Shaft Stop Dog Set Screw, for 2770..
356C	22230	" " Knee Arm Hub Set Screw, for 2766.....
356C	22230	Rock Shaft Knee Plate Set Screw, for 2767
375C	22220	Feed Connecting Link Hinge Screw, for 52393.....
375C	22220	Feed Forked Connection Hinge Screw.....
375C	22220	" Lifting Rock Shaft Connecting Rod Hinge Screw.....
401E	22225	Arm Shaft (horizontal) Ball Bearing (front) Cover Screw, for 127199.....
419E	2834	Bobbin Winder Tension Disc Screw Stud, for 27308.....
423C	22218	Arm Shaft (horizontal) Intermediate Bushing Set Screw.....
432C	22218	Arm Shaft (upright) Bushing (lower) Set Screw.....
435C	22218	Arm Shaft (horizontal) Flanged Bushing (front) Set Screw, for 96-80 and 96-86 Machines.....
435C	22218	Thread Take-up Lever Link Hinge Pin Set Screw.....
443C	22218	Arm Shaft (upright) Bushing (upper) Set Screw.....
446C	22225	Arm Shaft (horizontal) Ball Bearing (back) Locking Pin Cone Screw, for 96-100 Machine.....
448C	22218	Arm Shaft (horizontal) Flanged Bushing (back) Set Screw, for 96-80 and 96-86 Machines.....
448C	22218	Balance Wheel Set Screw, for 52176.....
448C	22218	Feed and Feed Lifting Eccentric Set Screw, for 127202.....
448C	22218	Lifting Lever Pin Set Screw, for 12237..
448C	22218	Thread Take-up Spring Regulator Set Screw.....
453C	5936	Presser Bar Guide Bracket Set Screw, for 52338.....
457C	22225	Bobbin Winder Frame Hinge Pin Set Screw, for 41583.....
457C	22225	Bobbin Winder Stop Latch Hinge Stud Set Screw, for 41913.....

NUMERICAL LIST OF PARTS

No.	Plate	Name
460C	22227	Bobbin Winder Tension Stud Set Screw, for 150459.....
560B	22227	Ruffler Driving Lever Adjusting Thumb Screw (upper) for 121121.....
590J	22227	Hemmer Adjusting Screw, for 35540.....
591F	22224	Rotating Hook Bobbin Case Tension Regulating Screw, for 52236.....
592E	22224	Rotating Hook Bobbin Case Latch Stop Screw, for 52237.....
624C	22224	Thread Retainer Set Screw.....
665J	21817	Presser Foot Spring Guide Screw, for 36465.....
688W	7726	Pressure Regulating Thumb Screw.....
689C	5936	Presser Bar Lifter Hinge Screw.....
691F	7727	Throat Plate Screw.....
704J	22224	Rotating Hook Bobbin Case Holder Position Bracket Screw.....
725J	22220	Bed Slide Spring Screw, for 12432.....
766D	22230	Lifting Lever Link Hinge Screw, for 52319 and 52320.....
775E	22222	Needle Bar Connecting Link Cap Screw, for 52270.....
802D	22230	Lifting Lever Hinge Screw, for 52319 and 52320.....
816W	22222	Feed Regulator Thumb Screw, for 52093...
854E	22217	Arm Screw (front).....
880E	22227	Bobbin Winder Screw, for 41915.....
966E	22220	Feed Lifting Rock Shaft Connecting Rod Cap Screw, for 127156.....
1036C	22218	Arm Shaft (horizontal) Bevel Gear Set Screw, for 127072.....
1036C	22218	Thread Take-up Crank Set Screw, for 52246, 127253 and 127254.....
1037C	22225	Thread Take-up Crank Position Screw, for 52246, 127253 and 127254.....
1053E	22224	Rotating Hook Thread Guard Screw, for 127096.....
1065C	22222	Needle Bar Crank Position Screw, for 52246, 127253 and 127254.....
1128E	22222	Feed Regulator Hinge Screw.....
1133E	22222	Needle Bar Bushing (lower) Set Screw....
1133E	22222	" " (upper) Set Screw....
1148C	22224	Rotating Hook Shaft Bushing (back) Set Screw.....
1148C	22224	Rotating Hook Shaft Bushing (front) Set Screw.....
1253C	22224	Rotating Hook Set Screw, for 127095.....
1259C	22218	Arm Shaft (upright) Bevel Gear (lower) Set Screw, for 52281.....

NUMERICAL LIST OF PARTS

No.	Plate	Name
1259C	22218	Arm Shaft (upright) Bevel Gear (upper) Set Screw, for 52232.....
1259C	22218	Rotating Hook Shaft Bevel Gear Set Screw for 127073.....
1299C	22220	Feed and Feed Lifting Eccentric Position Screw, for 127202.....
1367E	22224	Rotating Hook Section Screw, for 127097 and 127239.....
1380E	22224	Rotating Hook Bobbin Case Tension Spring Screw, for 52236.....
1429D	2834	Bobbin Winder Frame Hinge Screw, for 60456.....
1430D	2834	Bobbin Winder Stop Latch Hinge Screw, for 60456.....
1430D	2834	Bobbin Winder Stop Latch Lever Hinge Screw, for 60456.....
1443B	22227	Hemmer Screw, for 35540.....
1443J	22227	Piping Attachment Screw, for 35245.....
1513J	22222	Feed Lifting Rock Shaft Screw Center Nut, for 52097.....
1513J	22222	Feed Rock Shaft Screw Center Nut, for 52097.....
1518J	22220	Feed Connecting Link Hinge Screw Nut, for 52393.....
1518J	22220	Feed Forked Connection Hinge Screw Nut..
1518J	22220	Feed Lifting Rock Shaft Connecting Rod Hinge Screw Nut.....
1519J	22220	Feed Bar Screw Center Nut, for 56813....
1520J	5936	Presser Bar Lifter Hinge Screw Nut.....
1521E	22230	Lifting Lever Connecting Rod Lock Nut, for 52319 and 52320.....
1550H	2834	Bobbin Winder Stop Latch Hinge Screw Nut, for 60456.....
1560C	22224	Tension Regulating Thumb Nut, for 52098..
1562J	2834	Bobbin Winder Tension Disc Regulating Thumb Nut, for 27308.....
1700J	22228	Ruffler Driving Lever Hinge Screw Nut, for 121123.....
1772J	22228	Ruffler Ruffling Blade Holder Hinge Screw Nut, for 121123.....
2102	3471	Bobbin Winder Tension Disc, for 225462..
2102	3471	Tension Disc, for 52397.....
2103	7726	Tension Spring, for 52397.....
2106	2834	Bobbin Winder Tension Thread Guide, for 27308.....
2455	22227	Bobbin Winder Tension Disc, for 27308 and 150460.....
2763	819	Rock Shaft, for 4880.....
2763	21823	" " " 12250.....

NUMERICAL LIST OF PARTS

No.	Plate	Name
2765	21823	Rock Shaft Knee Arm, for 2768.....
2766	21823	" " " " Hub with 356C, for 2768.....
2767	21823	Rock Shaft Knee Plate with 356C, for 2768
2768	-----	Rock Shaft Knee Arm complete, for 12250, Nos. 2765 to 2767.....
2770	819	Rock Shaft Stop Dog with 356C, for 4880.
2770	21823	" " " " " 356C, for 12250
2778	21823	" " Lifting Bracket Hook, for 12250.....
2974	22224	Rotating Hook Bobbin Case Latch Lever Fulcrum Pin, for 40393.....
2975	22222	Rotating Hook Bobbin Case Latch Spring, for 52237.....
3146	22227	Binder Thumb Screw Washer, for 121168...
4307	22220	Bed Slide Spring, for 12432.....
4879	7730	Chain Connecting Link, for 4885.....
4880	819	Rock Shaft complete, for 52319, Nos. 2763 2770, 7125, 12243 and two each 6337 and 12242.....
4881	819	Treadle, for 4885.....
4882	22230	" Shaft, for 4885.....
4883	22230	" Spring, for 4885.....
4884	819	" Stand, for 4885.....
4885	819	Treadle complete, for 52319, Nos. 4879, 4881 to 4884 and two wood screws 1 in. No. 16 F.H.....
5596	22226	Bell Crank, for 56848.....
5598	22226	Bell Crank complete, for 52319 and 52320 Nos. 5735 and 56848.....
5599	22226	Bell Crank Bracket, for 56848.....
5601	22230	" " Hinge Pin, for 56848.....
5670	-----	Chain, length 26 in. to 35 in. with 56864 and 56865, for 52319.....
5735	7730	Bell Crank Spring, for 5598.....
6267	-----	Hemmer Folder, for 36122.....
6337	819	Rock Shaft Lifting Bracket with two 356C for 4880.....
6337	21823	Rock Shaft Lifting Bracket with two 356C for 12250.....
7125	819	Rock Shaft Lifting Bracket Hook, for 4880
7298	7726	Presser Foot Hinge Pin, for 19336.....
7539	21823	Rock Shaft Hanger with two wood screws 1 in. No. 10 F.H., for 12250.....
7958	22225	Bobbin Winder Stop Latch Stop Pin, for 60845.....
8879	5936	Arm Spool Pin Washer (cloth).....
8879	5936	Bobbin Winder Tension Bracket Spool Pin Washer (cloth) for 150461.....

NUMERICAL LIST OF PARTS

No.	Plate	Name
8879	5936	Binder Tape Reel Washer (cloth) for 121412.....
8908	21835	Wrench for 1519 and 1520 (Accessories)..
8909	21835	" " 1513 and 1518 (Accessories)..
9331	2834	Bobbin Winder Washer, for 41347.....
10141	2834	" " Tension Spring, for 27308.
11170	5936	Presser Bar Spring Washer.....
11204	22225	Thread Take-up Lever Link Hinge Pin, for 52269.....
11241	2833	Bobbin Winder Spool Washer (cloth) for 27308.....
11656	21819	Binder Tape Reel Arm Steady Pin, for 121412.....
12237	22223	Lifting Lever with 448C, for 52319 and 52320.....
12240	22230	Lifting Lever Pin, for 52319 and 52320..
12241	5936	" " Link, for 52319 and 52320.
12242	819	Rock Shaft Hanger with two wood screws 1 in. No. 10 F.H., for 4880.....
12243	819	Rock Shaft Lifting Bracket Hook, for 4880
12250	21823	Rock Shaft complete, for 52320, Nos. 2763 2768, 2778, 6337 and two each 2770 and 7539.....
12327	5936	Presser Bar Lifting and Releasing Lever Bracket.....
12329	5936	Tension Releasing Lever Spring.....
12361	7730	Machine Hinge Connection, for 44140.....
12391	22221	Presser Bar (hollow).....
12398	5936	Tension Releasing Lever Hinge Pin.....
12416	5936	Lifting Lever Connecting Rod Joint, for 52319 and 52320.....
12431	-----	Bed Slide, for 12432.....
12432	21806	Bed Slide complete, Nos. 4307, 12431 and two 725J.....
14010	22225	Bed Frame Hinge Plate Rivet, for 20067..
*15404	-----	Trade Mark, for 127263 and 127264.....
15405	-----	" " Rivet, for 127263 and 127264
16532	22217	Arm Dowel Pin.....
16555	7730	Bed Frame Hinge Plate, for 20067.....
19219	22225	" " Cushion (leather) for 20067...
19220	7730	" " Spring, for 20067.....
19226	7730	" " Hinge Connection, for 19398...
19334	-----	Presser Foot Plate, for 19336.....
19335	-----	" " Shank, for 19336.....
19336	7726	Presser Foot (hinged) complete, for 96-80 and 96-100 Machines, Nos. 7296, 19334 and 19335.....
19397	22225	Bed Frame Hinge Connection Cap, for 19398

NUMERICAL LIST OF PARTS

No.	Plate	Name
19398	-----	Bed Frame Hinge Connection 19226 with 211E and 19397, for 20067.....
20022	22225	Machine Cushion (felt) Accessories.....
20067	819	Bed Frame with two each 16555, 19398, four each 19219, 19220, six each 14010, wood screws 1-1/4 in. No. 12 F.H. and eight 158C.....
20123	5882	Throat Plate, for 20163, for 35540.....
20163	5882	Feed Dog, for 1/16 in. stitch, 16 teeth (16 teeth to the inch) for 20123, for 35540.....
20284	22223	Feed Forked Connection, for 52393.....
24041	22222	Needle Bar Connecting Stud with 207E, for 127232.....
24544	-----	Presser Foot Plate, for 24983.....
24982	-----	" " Shank, for 24983.....
24983	7726	Presser Foot (spring hinged) complete, for 96-86 Machine, Nos. 24544, 24982, 26231 and 62527.....
25446	22227	Bobbin Winder Screw Washer, for 41915...
25866	22221	Guide.....
*25868	-----	Hammer Tongue, for 36122.....
26026	21835	Screw Driver (large) Accessories.....
26231	7726	Presser Foot Spring, for 24983.....
26485	21835	Screw Driver (small) Accessories.....
26603	21818	Feed Dog, 20 teeth (16 teeth to the inch) for 26605, 26606, 35208 and 35236.....
26605	21818	Throat Plate, large needle hole, for 26603.....
26606	-----	Throat Plate, small needle hole, for 26603.....
27306	2834	Bobbin Winder Spool Pin, for 27308.....
27307	2833	" " Stand, for 27308....
27308	2833	Bobbin Winder Spool Stand complete, for 41348, Nos. 418E, 1562J, 2106, 10141 11241, 27306, 27307 and two each 2455 and wood screws 1 in. No. 10 F.H.....
27739	7234	Thread Unwinder Thread Cone (wood) for large cones, for 225258.....
27878	22225	Machine Cushion Rivet (Accessories).....
29633	22222	Feed Rock Shaft Crank with 157J, for 52387.....
32572	7726	Tension Releasing Disc, for 52397.....
32574	7726	" " Pin, for 52397.....
34105	21834	Bobbin Winder Frame Hinge Pin, for 60845.
35208	1971	Binder on Shank, to turn in both edges, for bias or straight binding, for skirts, wrappers, shirt waists, etc.

NUMERICAL LIST OF PARTS

No.	Plate	Name
35236	1971	Hemmer on Shank, for 7/16 in. hem and above, for bottom of shirt waists...
35245	21817	Piping Attachment complete, for piping house dresses, Nos. 1443J and 120977
35540	5882	Hemmer on Shank (adjustable) complete, with right hand lower guide, for lace, Nos. 1443B, 35926, 35927 and two 590J.....
35682	21817	Hemmer (foot) 1/8 in. hem, with guide on bottom to the right of needle hole..
35710	-----	Hemmer (foot) 3/32 in. hem, with guide on bottom to the right of needle hole..
35926	-----	Hemmer, for 35540.....
35927	-----	" Shank, for 35540.....
35997	-----	" (foot) 3/16 in. hem, with guide on bottom to the right of needle hole..
36072	-----	Hemmer (foot) 1/4 in. hem, with guide on bottom to the right of needle hole..
36122	-----	Hemmer (foot) for 7/32 in. hem.....
36309	-----	" " 7/32 in. hem, with guide on bottom to the right of needle hole..
36413	-----	Hemmer (foot) plain bottom, for 1/16 in. hem.....
36414	-----	Hemmer (foot) plain bottom, for 3/32 in. hem.....
36416	-----	Hemmer (foot) plain bottom, for 3/16 in. hem.....
36464	21817	Presser Foot Spring Guide, for 36465....
36465	21817	" " (right hand spring guide) with 665J and 36464, for 1/32 in. to 5/16 in. gauges.....
36460	-----	Hemmer (foot) plain bottom, for 5/32 in. hem.....
36524	-----	Hemmer (foot) 5/32 in. hem, with guide on bottom to the right of needle hole.....
36574	22228	Presser Foot, for 36575.....
36575	-----	" " 36574 with 36576 and two 50202J.....
36576	22228	Presser Foot Finger Guard, for 36575....
36637	22228	Ruffler Frame Spring Plate, for 121123...
36638	22228	" Ribbon Guide, for 121123.....
36641	22228	" Ruffling Blade Holder Guide, for 121123.....
36642	22228	Ruffler Ruffling Blade Holder Guide Rivet, for 121123.....
36644	22228	Ruffler Separating Blade, for 121501....
36644	22228	" Shirring Blade, for 120819.....
36646	22228	" Separating Blade Holder Friction Spring, for 121123.....

NUMERICAL LIST OF PARTS

No.	Plate	Name
36647	22228	Ruffler Separating Blade Holder Hinge Stud, for 121123.....
36648	22228	Ruffler Separating Blade Holder Stop Stud, for 121123.....
36714	-----	Presser Foot with 233J, for 36717.....
36715	21817	" " Guide (right) with 36716, for 36717.....
36716	21817	Presser Foot Guide Stud, for 36715.....
36717	21817	Presser Foot complete with Adjustable Guide (right) Nos. 36714 and 36715..
36773	21819	Presser Foot, for braiding.....
36819	22227	Finger Guard Friction Washer, for 121327
36820	22227	" " Holder with 196J, for 121327
40264	22222	Rotating Hook Bobbin.....
40274	22224	" " Section, for 127097 and 127239.....
40316	-----	Presser Foot Plate, for 40318.....
40317	-----	" " Shank, for 40318.....
40318	5882	Presser Foot (hinged) complete, for lace running, for 35540, Nos. 40316, 40317 and 62527.....
40392	22222	Rotating Hook Bobbin Case Latch, for 40393.....
40393	-----	Rotating Hook Bobbin Case Hinge, Nos. 2974, 40392 and 125320, for 52237...
40394	22222	Rotating Hook Bobbin Case Tension Spring, for 52236.....
41339	2833	Bobbin Winder Base, for 60456.....
41340	2833	" " Frame, for 60456.....
41341	2833	" " Spring, for 60456...
41342	2833	" " Pulley with 200F, for 60456
41343	2834	" " Spindle, for 60456.....
41344	2834	" " Stop Latch, for 60456.....
41345	2834	" " " Finger, for 60456.....
41346	2834	Bobbin Winder Stop Latch Lever, for 60456
41347	2833	" " for 41348, Nos. 60456 and two each 9331 and wood screws 1 in. No. 10 R.H.....
41348	-----	Bobbin Winder (swinging automatic, right hand) complete, Nos. 27308 and 41347
41400	22226	Machine Rest Pin (wood) Accessories....
41583	21834	Bobbin Winder Frame with 457C, for 60845
41585	21834	" " Pulley with 171J, for 60845
41586	21834	" " Spindle, for 60845.....
41587	21834	" " Stop Latch, for 60845.....
41588	21834	" " " Tripping Arm with 185H, for 60845.....
41593	5936	Bobbin Winder Tension Spring, for 150460

NUMERICAL LIST OF PARTS

No.	Plate	Name
41594	5936	Bobbin Winder Tension Stud, for 150460..
41595	5936	" " " Thread Guide, for 150460.....
41913	21834	Bobbin Winder Bracket with 457C, for 60845.....
41914	21834	Bobbin Winder Frame Spring, for 60845...
41915	21834	" " 60845 with 880E and 25446, for 150461.....
42367	22217	Arm Oil Tube Packing (braided cotton) for 52185 and 127187.....
42614	21834	Bobbin Winder Stop Latch Hinge Stud, for 60845.....
43525	21818	Binder Steady Pin, for 121398.....
43944	5936	Tension Releasing Lever.....
44139	7730	Machine Hinge Plate, for 44140.....
44140	-----	Machine Hinge complete, Nos. 12361, 44139 and merlized wood screw 1-1/4 in. No. 14 F.H. (Accessories).....
44212	7734	Drip Pan with four 1 in. wire nails.....
44253	22228	Feed Dog, 16 teeth (16 teeth to the inch) for 35245, 44255 and 44256....
44255	-----	Throat Plate (small needle hole) for 44253.....
44256	22228	Throat Plate (large needle hole) for 44253.....
50053W	22218	Arm Side Cover Thumb Screw.....
50083C	22220	Feed Connecting Link Hinge Stud Set Screw, for 52074.....
50117E	22220	Feed Dog Screw.....
50190W	22220	Face Plate Thumb Screw.....
50190W	22220	Guide Thumb Screw.....
50191C	22220	Feed Lifting Rock Shaft Screw Center, for 52097.....
50191C	22220	Feed Rock Shaft Screw Center, for 52097.
50202J	22228	Presser Foot Finger Guard Screw, for 36575.....
50203F	22227	Ruffler Needle Clamp Screw, for 120875..
50302J	22227	Finger Guard Holder Set Screw, for 120858
50304C	7726	Tension Stud, for 52098.....
50305C	22224	" " Set Screw, for 52083.....
50316J	22227	Finger Guard Screw, for 121327.....
51068E	22218	Arm Shaft (horizontal) Bevel Gear Case Screw, for 142003.....
51068E	22218	Rotating Hook Shaft Bevel Gear Case Screw, for 142004.....
51097J	22227	Binder Thumb Screw, for 121168.....
51097J	22227	" Tape Reel Arm Thumb Screw, for 121168.....
51219F	22227	Ruffler Driving Lever Hinge Screw, for 121123.....

NUMERICAL LIST OF PARTS

No.	Plate	Name
51221F	22228	Ruffler Ruffling Blade Holder Hinge Screw, for 121123.....
51371K	22227	Ruffler Driving Lever Adjusting Thumb Screw (lower) for 121121.....
51460F	22222	Needle Clamp Screw, for 52307.....
52014	22221	" Bar Bushing (upper).....
52016	5936	Presser Bar Lifter.....
52018	22224	Rotating Hook Bobbin Case Holder Position Bracket.....
52022	22225	Thread Take-up Lever with 52130, for 52025.....
52023	22225	Thread Take-up Lever Hinge Pin, for 52025
52024	22225	" " " Link, for 52025....
52025	-----	Thread Take-up Lever complete, for 52269 Nos. 52022 to 52024.....
52027	7726	Thread Guard (side of arm).....
52028	22226	Lifting Lever Connecting Rod, for 52319 and 52320.....
52051	22226	Face Plate, for 52052.....
52052	-----	Face Plate complete, Nos. 52051, 52053, 52170 and two 226J.....
52053	22220	Face Plate Thread Guard (lower) for 52052.....
52055	21819	Presser Foot, for 35208 and 35236.....
52056	21817	" " " 35245.....
52073	22220	Feed Connecting Link Hinge Stud, for 52118.....
52074	22221	Feed Regulator with 50083C, for 52118...
52083	7726	Thread Take-up Spring Regulator with 50305C, for 52397.....
52093	-----	Feed Regulator 52118 with 818W.....
52097	-----	" Lifting Rock Shaft Screw Center 50191C with 1513J.....
52097	-----	Feed Rock Shaft Screw Center 50191C with 1513J.....
52098	-----	Tension Stud 50304C with 1560C, for 52397
52118	-----	Feed Regulator 52074 with 52073, for 52093.....
52130	22225	Thread Take-up Lever Thread Eyelet Bushing, for 52022.....
52146	22225	Arm Shaft (horizontal) Back Bearing Oil Cup Pad (braided cotton) for 96-100 Machine.....
52146	22225	Arm Shaft (horizontal) Front Bearing Oil Pad (braided cotton) for 96-100 Machine.....
52165	22220	Feed Connecting Link, for 52393.....
52170	22220	Face Plate Thread Guard (upper) for 52052.....

NUMERICAL LIST OF PARTS

No.	Plate	Name
52176	22226	Balance Wheel (power, disc) 2-3/16 in. pulley, with two 448C.....
52180	22217	Arm Oil Tube (long) with 52184, for oiling 52022.....
52182	22217	Arm Oil Tube with 52184, for oiling 127231.....
52183	22217	Arm Oil Tube with 52184, for oiling 52024 and 127156, for 127193 and 150460.....
52184	22217	Arm Oil Tube Packing (wick) for 52180, 52182 and 52183.....
52184	22217	Oil Tube Packing (wick) for 127191.....
52185	22217	Arm Oil Tube (short) with 42367, for oiling 52022.....
52193	22218	Arm Shaft (horizontal) Flanged Bushing (back) Oil Pad (inside) braided cotton, for 52260.....
52193	22218	Arm Shaft (horizontal) Flanged Bushing (front) Oil Pad (inside) braided cotton, for 52196.....
52193	22218	Arm Shaft (horizontal) Intermediate Bushing Oil Pad (inside) braided cotton, for 52262.....
52195	-----	Arm Shaft (horizontal) Flanged Bushing (front) for 52196.....
52196	22219	Arm Shaft (horizontal) Flanged Bushing (front) 52195 with 52193 and 52195, for 127266 and 127284.....
52198	22218	Arm Shaft (horizontal) Flanged Bushing (front) Oil Pad (outside) felt, for 52196.....
52207	22222	Needle Bar Connecting Link Lubricating Pad (wood) for 127231.....
52210	22220	Feed and Feed Lifting Eccentric Lubricating Pad (long) wood, for 127202..
52211	22220	Feed and Feed Lifting Eccentric Lubricating Pad (short) wood, for 127202..
52216	22224	Thread Take-up Crank, for 52270.....
52235	-----	Rotating Hook Bobbin Case, for 52236....
52236	-----	" " " " 52235 with 591F, 1380E and 40394, for 52237....
52237	22224	Rotating Hook Bobbin Case complete, for 127240 and 127241, Nos. 592E, 2975, 40393 and 52236.....
52239	22218	Arm Spool Pin and Thread Eyelet, for 127193.....
52239	22218	Bobbin Winder Tension Bracket Spool Pin and Thread Eyelet, for 150460.....

NUMERICAL LIST OF PARTS

No.	Plate	Name
52246	22221	Needle Bar Crank with 1036C, 1037C and 1065C, for 127284.....
52254	22217	Arm Oil Tube for oiling 52261....
52259	-----	Arm Shaft (horizontal) Flanged Bushing (back) for 52260.....
52260	22219	Arm Shaft (horizontal) Flanged Bushing (back) 52259 with 52193 and 52289, for 96-80 and 96-86 Machines.....
52261	-----	Arm Shaft (horizontal) Intermediate Bushing, for 52262.....
52262	22219	Arm Shaft (horizontal) Intermediate Bushing 52261 with 52193 and 52263..
52263	22218	Arm Shaft (horizontal) Intermediate Bushing Oil Pad (outside) felt, for 52262.....
52265	22219	Feed Lifting Rock Shaft Crank 52271 with 157J and 52267, for 127269.....
52266	-----	Feed Lifting Rock Shaft Crank Slide Block, for 52267.....
52267	22220	Feed Lifting Rock Shaft Crank Slide Block 52266 with 125060, for 52265..
52269	-----	Thread Take-up complete, Nos. 11204, 52025 and 52270.....
52270	-----	Thread Take-up Crank 52216 with 775E and 127232, for 52269.....
*52271	-----	Feed Lifting Rock Shaft Crank, for 52265..
52275	-----	Arm Shaft (upright) Bushing (lower) for 52276.....
52276	22219	Arm Shaft (upright) Bushing (lower) 52275 with 52279 and 52280.....
52277	-----	Arm Shaft (upright) Bushing (upper) for 52278.....
52278	22219	Arm Shaft (upright) Bushing (upper) 52277 with 52279 and 52280.....
52279	22218	Arm Shaft (upright) Bushing Oil Wick (inside) braided cotton, for 52276 and 52278.....
52279	22218	Rotating Hook Shaft Bushing Oil Wick (inside) braided cotton, for 52286 and 52288.....
52280	22218	Arm Shaft (upright) Bushing Oil Pad (outside) felt, for 52276 and 52278..
52280	22218	Rotating Hook Shaft Bushing Oil Pad (outside) felt, for 52286 and 52288..
52281	22218	Arm Shaft (upright) Bevel Gear (lower) with two 1259C.....
52282	22218	Arm Shaft (upright) Bevel Gear (upper) with two 1259C.....

NUMERICAL LIST OF PARTS

No.	Plate	Name
52285	-----	Rotating Hook Shaft Bushing (back) for 52286.....
52286	22221	Rotating Hook Shaft Bushing (back) 52285 with 52279 and 52280.....
52287	-----	Rotating Hook Shaft Bushing (front) for 52288.....
52288	22221	Rotating Hook Shaft Bushing (front) 52287 with 52279 and 52280.....
52289	22218	Arm Shaft (horizontal) Flanged Bushing (back) Oil Pad (outside) felt, for 52260.....
52290	22217	Arm Oil Tube Hole Plug.....
52306	22222	Needle Bar Thread Guard, for 127116.....
52307	22222	" Clamp with 51460F, for 127116.....
52319	-----	Foot Lifter complete, Nos. 76D, 766D, 802D, 1521E, 4880, 4885, 5598, 5670, 12237, 12240, 12241, 12416, 52028 and two 178E.....
52320	-----	Knee Lifter complete (power table) Nos. 76D, 766D, 802D, 1521E, 5598, 12237, 12240, 12241, 12250, 12416, 52028 and two 178E.....
52337	5936	Slack Thread Regulator.....
52338	5936	Presser Bar Guide Bracket with 223C and 453C.....
52384	22223	Feed Lifting Rock Shaft, for 127269.....
52386	22223	" Rock Shaft, for 52387.....
52387	-----	Feed Rock Shaft complete, Nos. 29633 and 52386.....
52393	-----	Feed Forked Connection 20284 with 375C, 1518J and 52165.....
52394	7726	Thread Take-up Spring, for 52397.....
52397	-----	Tension complete, Nos. 2103, 32572, 32574 52083, 5209E, 52394 and two 2102....
52452	22219	Feed Bar.....
52454	22224	Thread Retainer.....
52462	7727	Feed Dog, 19 teeth (22 teeth to the inch) for 52463, for 96-86 Machine.....
52463	7727	Throat Plate, for 52462, for 96-86 Machine.....
52486	22225	Arm Shaft (horizontal) Ball Bearing (back) Locking Pin, for 96-100 Machine.....
52487	22225	Arm Shaft (horizontal) Ball Bearing (back) Locking Pin Cone, for 96-100 Machine.....
54897	22225	Arm Shaft (horizontal) Back Bearing Oil Cup, for 96-100 Machine.....

NUMERICAL LIST OF PARTS

No.	Plate	Name
54897	22225	Arm Shaft (horizontal) Front Bearing Oil Cup, for 96-100 Machine.....
56015	22217	Arm Oil Tube, for oiling 142006, for 127263 and 127264.....
56813	-----	Feed Bar Screw Center 313C with 1519J...
56848	-----	Bell Crank 5596 with 5599 and 5601, for 5598.....
56864	7730	Chain Hook (large) for 5670.....
56865	7730	" " (small) for 5670.....
60456	-----	Bobbin Winder, for 41347, Nos. 152F, 207J 1429D, 1550H, 41339 to 41346 and three 1430D.....
60845	-----	Bobbin Winder, for 41915, Nos. 7958, 34105, 41583, 41585 to 41588, 41913, 41914 and 42614.....
62527	22225	Presser Foot Hinge Pin, for 24983 and 40318.....
68350	22218	Arm Shaft (horizontal) Back Bearing Oil Cup, for 96-80 and 96-86 Machines...
68350	22218	Arm Shaft (horizontal) Front Bearing Oil cup, for 96-80 and 96-86 Machines...
120342	21835	Oiler (copper plated) with 120343 (Accessories).....
120343	21835	Oiler Spout, 3-1/2 in. long, for 120342.
120536	22226	Binder Tape Reel Disc with 120538 and 120539, for 121168.....
120537	-----	Binder Tape Reel Disc Pin, for 121412...
120538	-----	" " " Stud (wood) for 120536.....
120539	-----	Binder Tape Reel Disc Stud Sleeve, for 120536.....
120803	5919	Hemmer (foot) for 1/8 in. hem.....
120804	5919	" " " 5/32 in. hem.....
120805	5919	" " " 3/16 in. hem.....
120806	5920	" " " 1/4 in. hem.....
120807	5920	" " " 5/16 in. hem.....
120812	22228	Ruffler Driving Lever Bushing, for 121123
120813	22228	" " " Friction Washer, for 121123.....
120818	-----	Ruffler Shirring Blade Holder, for 120819
120819	-----	" " " " 120818 with 36644 and two 120829, for 121452....
120828	21817	Presser Foot (single toe) for gathering, for fine work.....
120829	22228	Ruffler Ruffling Blade Rivet, for 121120.
120829	22228	" Separating Blade Rivet, for 121501.....
120829	22228	Ruffler Shirring Blade Rivet, for 120819.

NUMERICAL LIST OF PARTS

No.	Plate	Name
120830	-----	Ruffler Separating Blade Holder, for 121501.....
120837	5920	Hemmer (foot) plain bottom, for 1/8 in. hem, slotted, for lace.....
*120838	5920	Hemmer Tongue, for 120804 and 120805....
*120839	5920	" " " 120806 and 120807....
*120843	5919	" " " 120803 and 120938....
120857	22227	Finger Guard, for 120860.....
120858	22227	" " Holder, with 50302J, for 120860.....
120860	22227	Finger Guard (wire) complete, Nos. 120857 120858 and two 236J.....
120875	22227	Ruffler Needle Clamp with 50203F, for 121452.....
120898	5921	Hemmer (foot) for 1/16 in. to 1/8 in. hem for China Silk, etc.....
120911	5921	Hemmer (foot) for 5/32 in. to 1/4 in. hem for China Silk, etc.....
120938	5921	Hemmer (foot) for 3/32 in. hem.....
120939	5920	" Folder, for 120803 to 120807 and 120938.....
120977	-----	Piping Attachment, for 35245.....
121116	22229	Ruffler Driving Lever, for 121123.....
121117	22229	" Frame, for 121123.....
121118	22228	" Ruffling Blade, for 121120.....
121119	22228	" " Holder, for 121120.....
121120	-----	" " " 121119 with 121118 and two 120829, for 121123....
121121	22229	Ruffler Ruffling Blade Lever with 560B and 51371K, for 121123.....
121123	22229	Ruffler complete, for 121452, Nos. 240B, 1700J, 1772J, 36637, 36638, 36641, 36642, 36646 to 36648, 51219F, 51221F 120812, 120813, 121116, 121117, 121120, 121121 and 121501.....
121167	22227	Binder Folder on Shank, for 121168.....
121168	-----	Binder (transverse) on Shank complete, for folded or unfolded bias binding (with tape reel) for general work, for 3/4 in., 7/8 in. and 1 in. tape, Nos. 3146, 120536, 121167, 121169, 121397, 121398, 121412 and two 51097J.....
121169	21819	Presser Foot, for 121168.....
121326	22227	Finger Guard, for 121327.....
121327	22227	Finger Guard (metal) complete, Nos. 36819 36820, 50316J and 121326.....
121397	21818	Feed Dog, 18 teeth (16 teeth to the inch) for 121168 and 121398.....

NUMERICAL LIST OF PARTS

No.	Plate	Name
121398	21818	Throat Plate with 43525, for 121168 and 121397.....
121412	21819	Binder Tape Reel Arm with 8879, 11656 and 120537, for 121168.....
121452	-----	Ruffler 121123 with 120819 and 120875....
121501	-----	" Separating Holder 120830 with 36644 and two 120829, for 121123....
121587	22223	Grease Gun (3 oz. capacity) for Fitting No. 142005 (Accessories).....
121588	-----	Grease Gun (1/2 lb. capacity) for Fitting No. 142005 (Accessories).....
*125060	-----	Feed Lifting Rock Shaft Crank Slide Block Stud, for 52267.....
125320	22222	Rotating Hook Bobbin Case Latch Lever, for 40393.....
127009	22221	Arm Shaft (horizontal) Ball Bearing (front) Cover, for 127199.....
127011	22221	Arm Shaft (horizontal) Ball Bearing (back) for 96-100 Machine.....
127066	22221	Arm Shaft (horizontal) Ball Bearing (front) for 96-100 Machine.....
127067	22225	Arm Shaft (horizontal) Ball Bearing (front) Key, for 127267.....
127072	22219	Arm Shaft (horizontal) Bevel Gear with two 1036C.....
127073	22224	Rotating Hook Shaft Bevel Gear with two 1259C.....
127079	22219	Arm Side Cover.....
127087	7727	Feed Dog, 19 teeth (16 teeth to the inch) for 127106 and 127107, for 96-80 and 96-100 Machines.....
127088	22221	Needle Bar (hollow) for 127116.....
127091	22221	Oil Tube Bracket, for 127092.....
127092	22221	" " " 127091 with 127191, for oiling 52165.....
127095	22222	Rotating Hook with three 1253C, for 127096.....
127096	-----	Rotating Hook 127095 with 127102 and four 1053E, for 127097 and 127239...
127097	-----	Rotating Hook 127096 with 40274 and three 1367E (for agents only).....
127102	22224	Rotating Hook Thread Guard, for 127096..
127106	7727	Throat Plate, large needle hole, for 127087, for 96-80 and 96-100 Machines
127107	-----	Throat Plate, small needle hole, for 127087, for 96-80 and 96-100 Machines
127108	22221	Presser Bar Spring.....
127116	-----	Needle Bar 127088 with 229J, 52306 and 52307.....

NUMERICAL LIST OF PARTS

No.	Plate	Name
*127143	-----	Arm Shaft (horizontal) Ball Bearing (back) Cover, for 127144.....
127144	22221	Arm Shaft (horizontal) Ball Bearing (back) Cover 127143 with 127145, for 96-100 Machine.....
*127145	-----	Arm Shaft (horizontal) Ball Bearing (back) Cover Oil Lead, for 127144....
127146	21806	Arm Side Cap.....
127152	22219	Feed and Feed Lifting Eccentric Sleeve, for 127225.....
127156	22223	Feed Lifting Rock Shaft Connecting Rod with two 966E.....
127187	22217	Arm Oil Tube (bent) with 42367, for oiling 127152, for 127193 and 150460....
127191	22221	Oil Tube with 52184, for 127092.....
127192	22219	Arm Top Cover, for 127193.....
127193	22219	" " " 127192 with 52183, 52239, 127187 and 127255.....
127199	-----	Needle Bar Crank 127254 with 401E and 127009, for 127268.....
127202	22219	Feed and Feed Lifting Eccentric with 448C, 1299C, 52210 and 52211, for 127225.....
127225	-----	Feed and Feed Lifting Eccentric 127202 with 127152.....
127230	22222	Needle Bar Bushing (lower).....
127231	22222	" " Connecting Link with 52207, for 127232.....
127232	-----	Needle Bar Connecting Link 127231 with 24041, for 52270.....
*127239	-----	Rotating Hook 127096 with 40274, 127242 and three 1367E, for 127240.....
127240	-----	Rotating Hook 127239 with 52237.....
127241	-----	" " Bobbin Case 52237 with 127242.....
127242	22224	Rotating Hook Bobbin Case Holder, for 127239 and 127241.....
127253	22221	Needle Bar Crank with 1036C, 1037C and 1065C, for 127266.....
127254	22221	Needle Bar Crank with 1036C, 1037C and 1065C, for 127199.....
127255	22218	Arm Top Cover Positioning Disc, for 127193.....
127255	22218	Bobbin Winder Tension Bracket Positioning Disc, for 150460.....
*127263	-----	Arm with 15404 and two each 15405 and 56015, for 96-80 and 96-86 Machines,
*127264	-----	Arm with 15404 and two each 15405 and 56015, for 96-100 Machine.....

NUMERICAL LIST OF PARTS

No.	Plate	Name
127265	22223	Arm Shaft (horizontal) for 127266 and 127284.....
127266	-----	Arm Shaft (horizontal) 127265 with 52196 and 127253, for 96-80 Machine.....
127267	22223	Arm Shaft (horizontal) with 127067, for 127268.....
127268	-----	Arm Shaft (horizontal) 127267 with 127199, for 96-100 Machine.....
127269	-----	Feed Lifting Rock Shaft complete, Nos. 52265 and 52384.....
*127270	-----	Bed.....
127284	-----	Arm Shaft (horizontal) 127265 with 52196 and 52246, for 96-86 Machine.....
127292	22223	Rotating Hook Shaft.....
140184E	22217	Arm Shaft (horizontal) Bevel Gear Case Plug Screw, for 142003.....
140184E	22217	Rotating Hook Shaft Bevel Gear Case Plug Screw, for 142004.....
142003	22219	Arm Shaft (horizontal) Bevel Gear Case (two pieces) with 51068E, 140184E and 142005.....
142004	22221	Rotating Hook Shaft Bevel Gear Case (two pieces) with 51068E, 140184E and 142005.....
142005	22217	Arm Shaft (horizontal) Bevel Gear Case Alemite Fitting, for 142003.....
142005	22217	Rotating Hook Shaft Bevel Gear Case Alemite Fitting, for 142004.....
142006	22219	Arm Shaft (upright).....
142008	22224	Rotating Hook Shaft Bushing (front) Oil Cup.....
150203	20335	Thread Unwinder Spool Rest Cushion (felt) for 225258.....
150459	21834	Bobbin Winder Tension Bracket with 460C, for 150460.....
150460	-----	Bobbin Winder Tension Bracket complete, for 150461, Nos. 41593 to 41595, 52183, 52239, 127187, 127255, 150459 and two 2455.....
150461	-----	Bobbin Winder (swinging automatic, left hand) complete, Nos. 41915 and 150460
200056E	3471	Bobbin Winder Stop Latch Screw, for 225382.....
200082D	3471	Bobbin Winder Tension Bracket Screw, for 225382.....
200299H	3471	Bobbin Winder Stop Latch Trip Lever Hinge Screw, for 225382.....

NUMERICAL LIST OF PARTS

No.	Plate	Name
200380C	3471	Bobbin Winder Pulley Set Screw, for 202473.....
200383C	22230	Thread Unwinder Spool Rest Rod Set Screw for 202490.....
201018C	22230	Thread Unwinder Spool Rest Set Screw, for 225257.....
201499B	3471	Bobbin Winder Tension Stud, for 225461..
201572B	3471	" " " " Thumb Nut, for 225462.....
201696J	22230	Thread Unwinder Thread Guide Lock Nut, for 225258.....
202277	3471	Bobbin Winder Frame Oil Packing (wick) for 225453.....
202407	3471	Bobbin Winder Tension Spring, for 225462.
202473	3470	" " Pulley with 200380C, for 225382.....
202478	3471	Bobbin Winder Stop Latch Trip Lever, for 225382.....
202490	20335	Thread Unwinder Spool Stand with 200383C for 225258.....
225257	20335	Thread Unwinder Spool Rest with 201018C, for 225258.....
225258	20335	Thread Unwinder complete, for two spools or two large cones of thread, Nos. 201696J, 202490, 225257, 225324, 225326, 225388, two each 150203, 225391 and three wood screws 7/8 in. No. 12 F.H.....
225322	22230	Thread Unwinder Thread Guide Rod Washer, for 225324.....
225324	20335	Thread Unwinder Thread Guide Rod with 208E and 225322, for 225258.....
225326	20335	Thread Unwinder Thread Guide Position Cup, for 225258.....
225381	3470	Bobbin Winder Spindle, for 225382.....
225382	3469	Bobbin Winder (swinging automatic, right hand) complete, for power table, Nos. 200056E, 200082D, 200299H, 202473, 202478, 225381, 225433, 225444, 225453 to 225456, 225458, 225462, 228026, two each 225459 and wood screws 3/4 in. No. 12 R.H.....
225388	20335	Thread Unwinder Spool Rest Rod, for 225258.....
225390	7234	Thread Unwinder Thread Cone Holder, for inverted cones, for 225258.....
225391	20335	Thread Unwinder Thread Guide, for 225258.
225433	3469	Bobbin Winder and Tension Bracket Base, for 225382.....

NUMERICAL LIST OF PARTS

No.	Plate	Name
225438	3471	Bobbin Winder Frame Oil Well Cap, for 225453.....
225444	3471	Bobbin Winder Stop Latch, for 225382....
225453	3470	" " Frame with 202277 and 225438, for 225382.....
225454	3471	Bobbin Winder Frame Hinge Pin, for 225382
225455	3471	" " " Spring, for 225382..
225456	3471	" " " Plunger, for 225382.....
225458	3471	Bobbin Winder Stop Latch Thumb Lever, for 225382.....
225459	3471	Bobbin Winder Stop Latch Thumb Lever Hinge Stud, for 225382.....
225459	3471	Bobbin Winder Stop Latch Thumb Lever Joint Stud, for 225382.....
225461	3471	Bobbin Winder Tension Bracket with 201499B, for 225462.....
225462	-----	Bobbin Winder Tension Bracket complete, for 225382, Nos. 201572B, 202407, 225461 and two 2102.....
228026	-----	Bobbin Winder Tension Bracket Screw Washer, for 225382.....

Genuine Singer Needles should be used in Singer Machines. These Needles and their Containers are marked with the Company's Trade Mark "SIMANCO." 1

Needles in Containers marked "For Singer Machines" are not Singer made needles. 2

PLATE 819—ONE-FOURTH SIZE

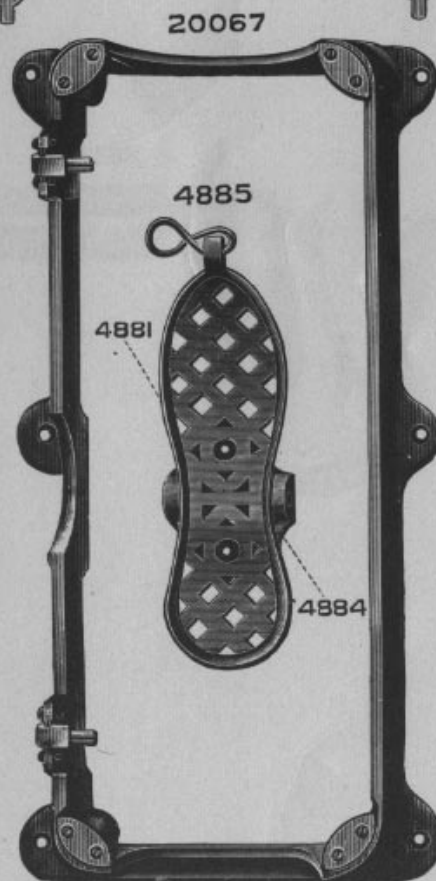
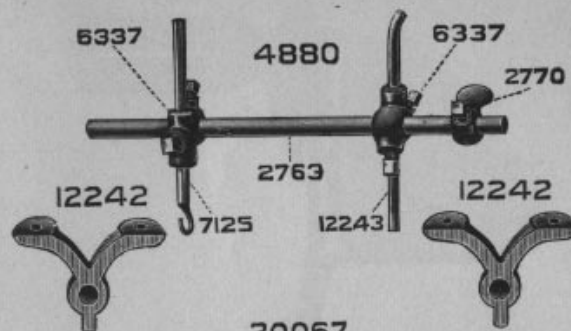

Genuine Singer Needles should be used
in Singer Machines.
These Needles and their Containers
are marked with the
Company's Trade Mark "SIMANCO." 1

Needles in Containers marked
"For Singer Machines"
are not Singer made needles. 2

PLATE 1971—ONE-HALF SIZE

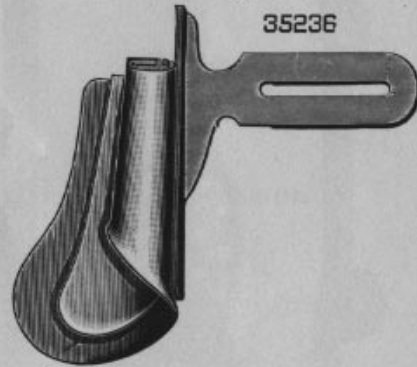
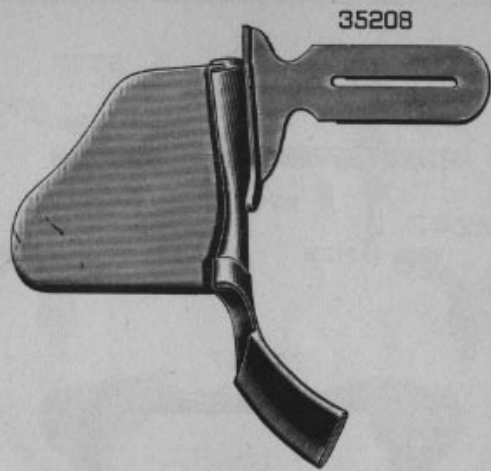
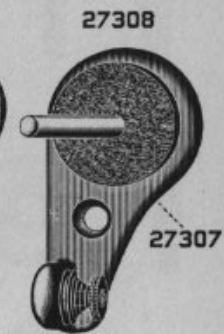
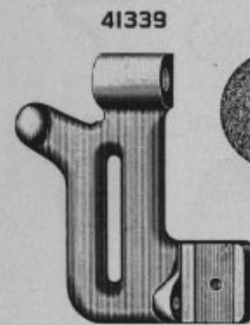
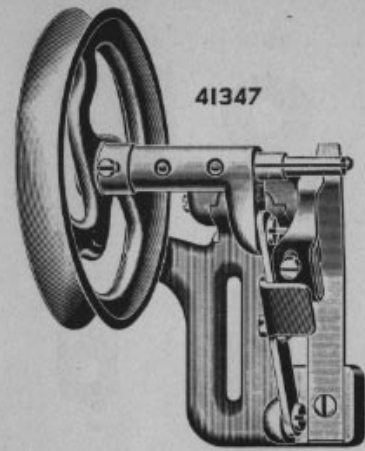

PLATE 2833—ONE-HALF SIZE



27307

PLATE 2834—FULL SIZE

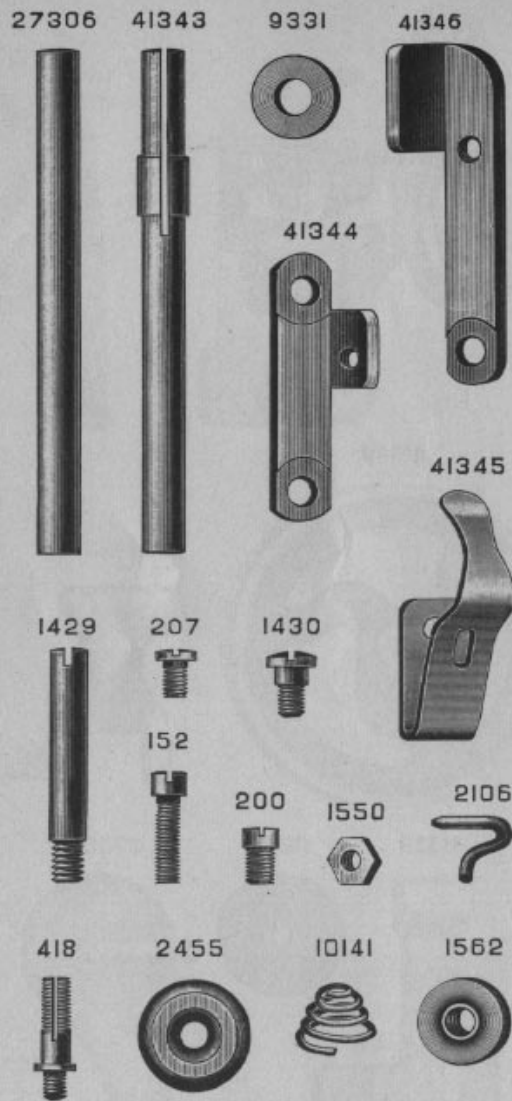

PLATE 3469—ONE-FOURTH SIZE

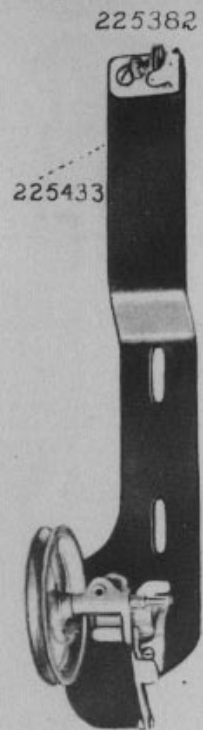

PLATE 3470—ONE-HALF SIZE

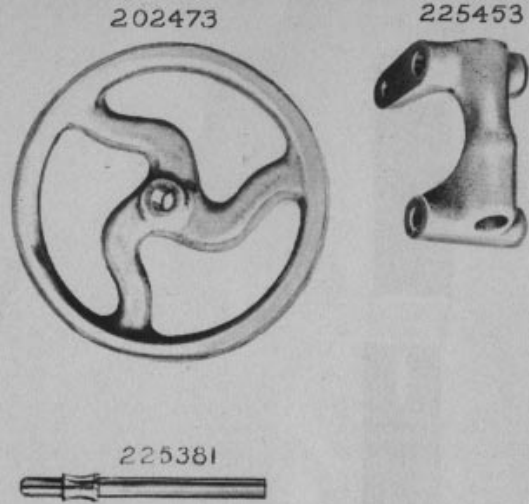

PLATE 3471—FULL SIZE

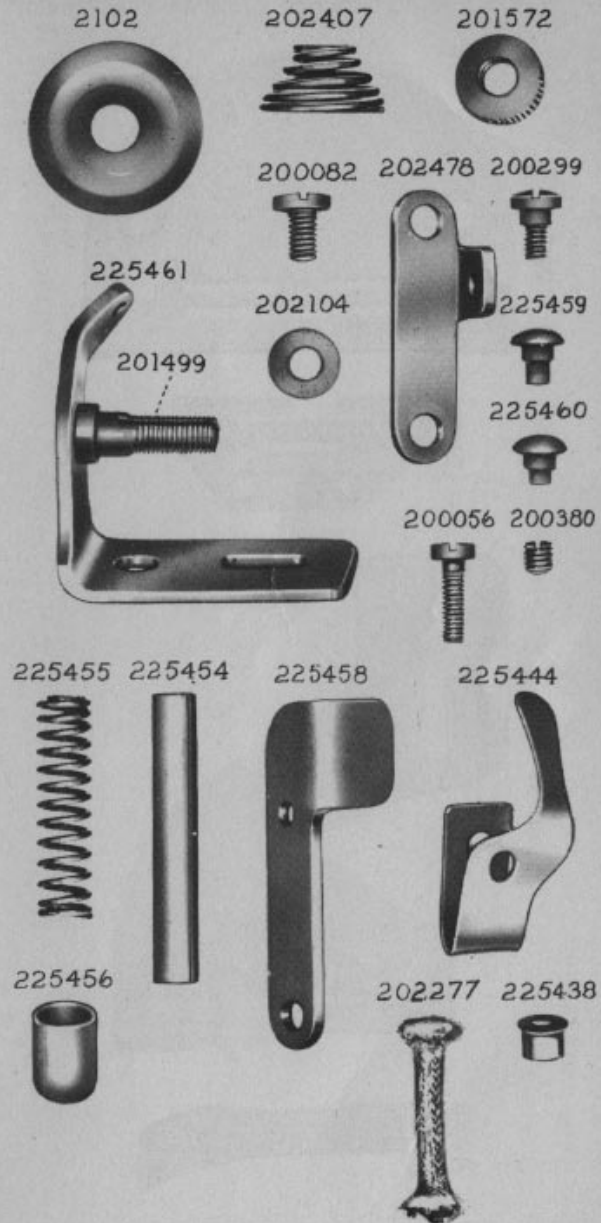
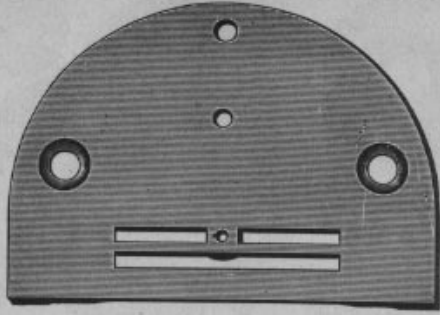
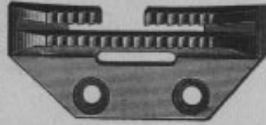

PLATE 5882—FULL SIZE

20123



20163



35540

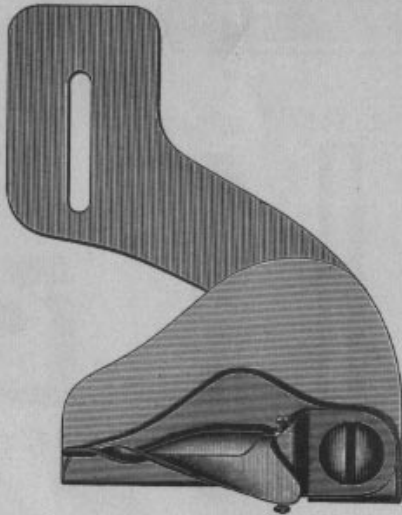

40318

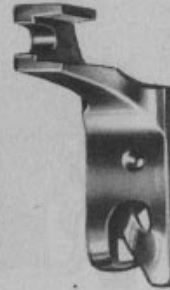

PLATE 5919—FULL SIZE

120803



120804



120805

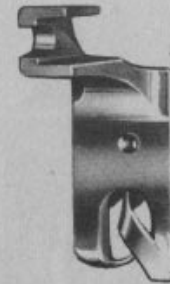

120939



120838



120843



PLATE 5920—FULL SIZE

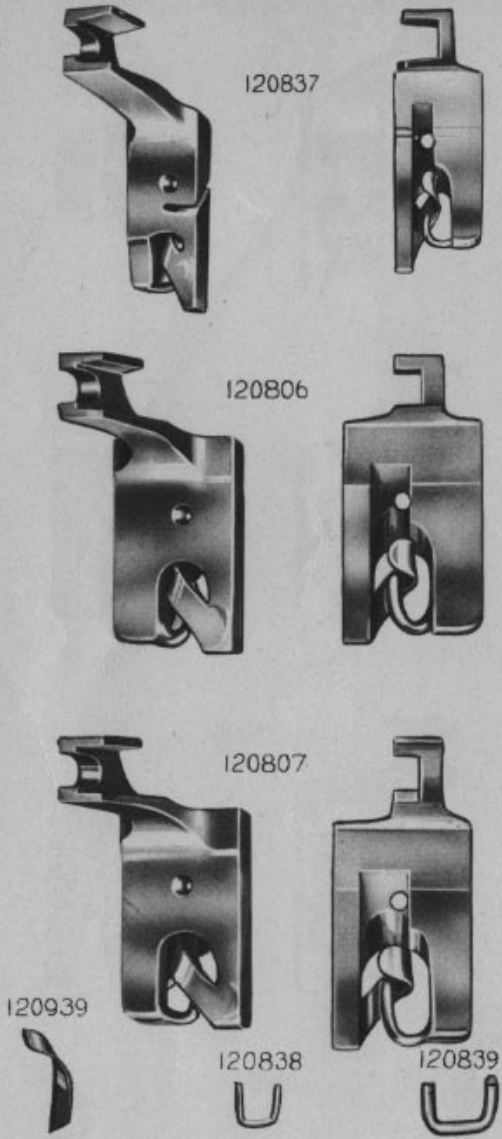

PLATE 5921—FULL SIZE

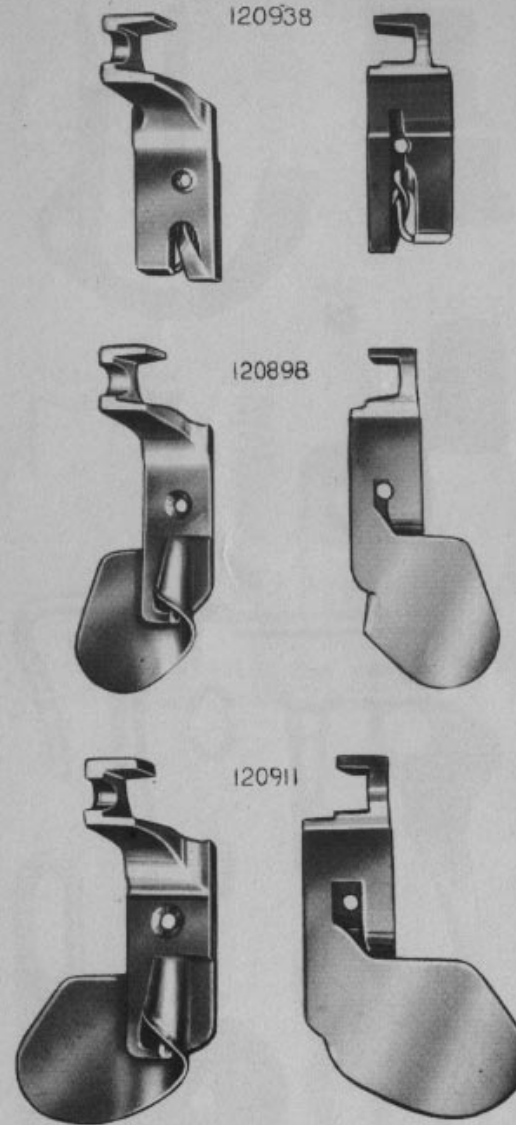

PLATE 5936—FULL SIZE

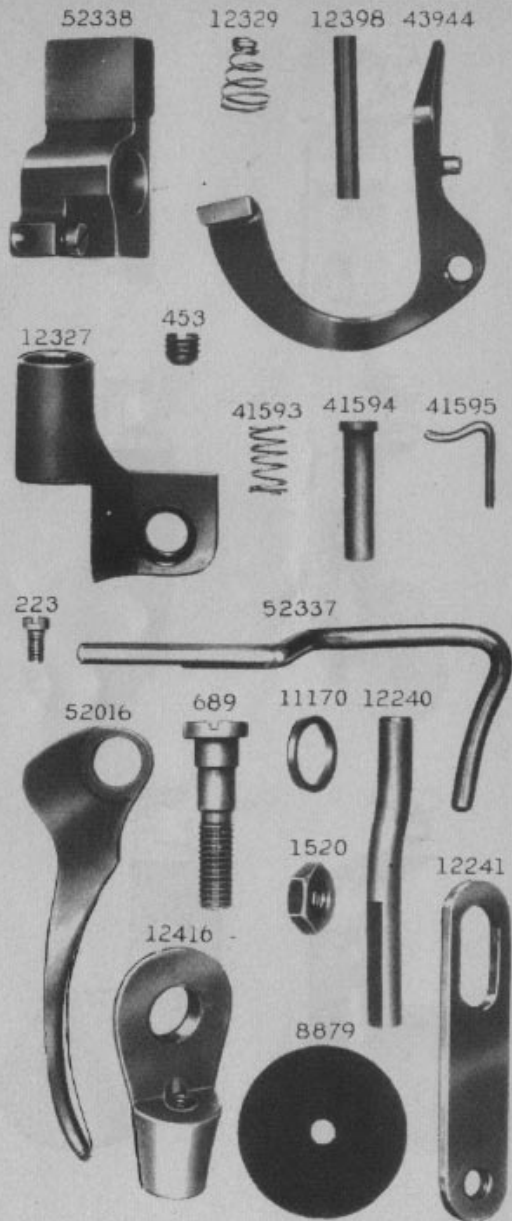

PLATE 7234—ONE-HALF SIZE

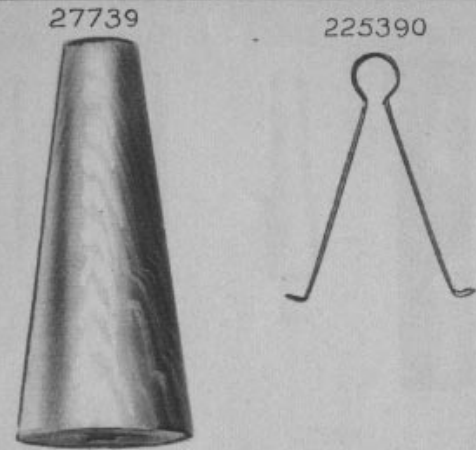

PLATE 7726—FULL SIZE

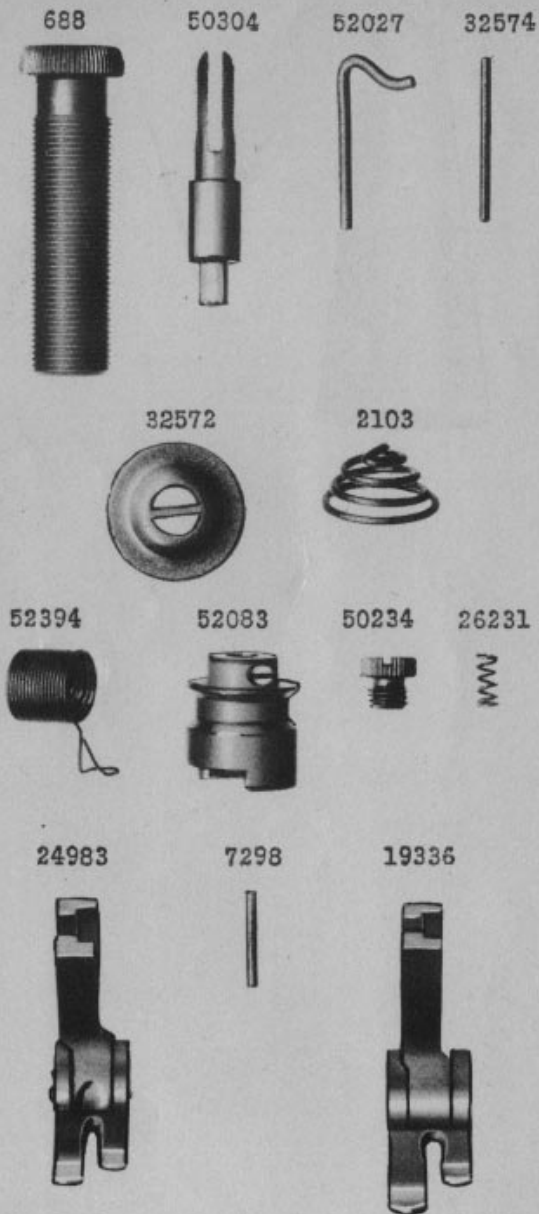

PLATE 7727—FULL SIZE

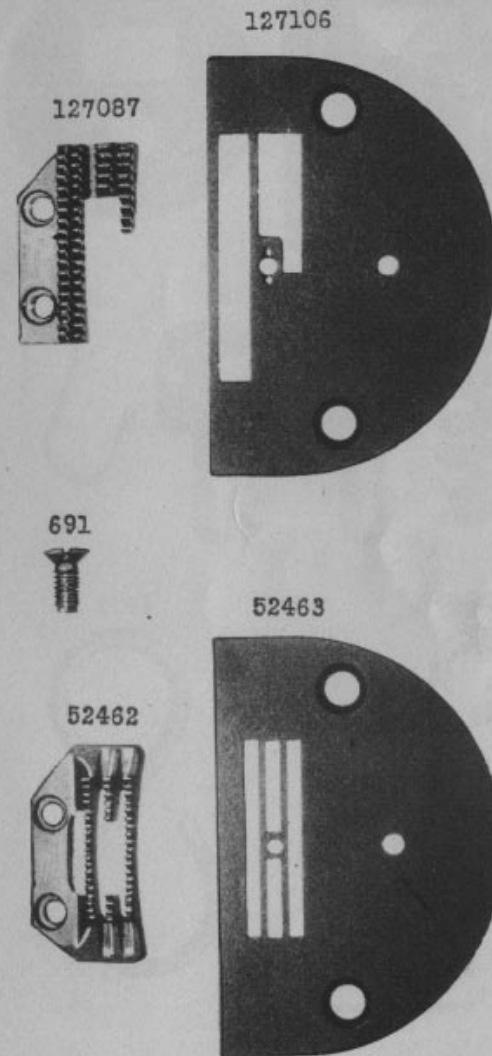
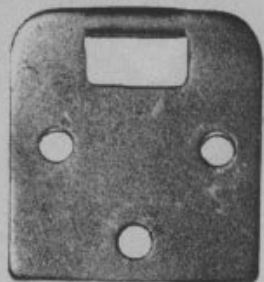
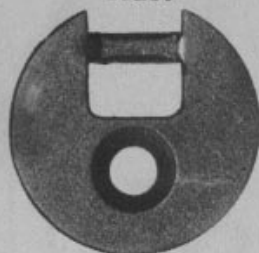

PLATE 7730—FULL SIZE

16555



44139



19220



12361



19226



56865



56864

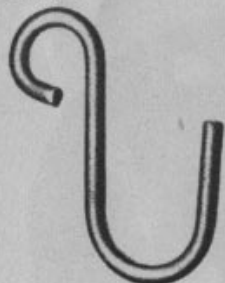

4879



5735



PLATE 7734—ONE-FOURTH SIZE

44212

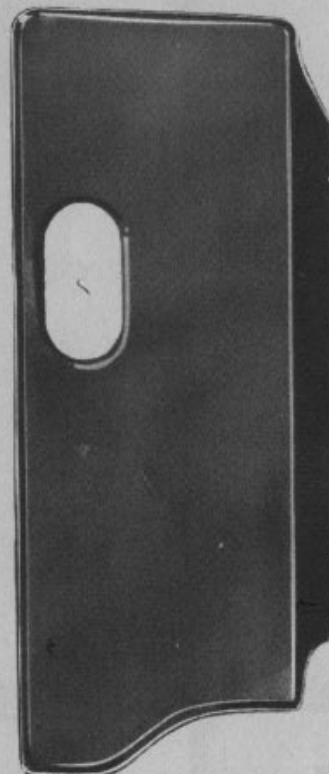

PLATE 20335—ONE-SIXTH SIZE

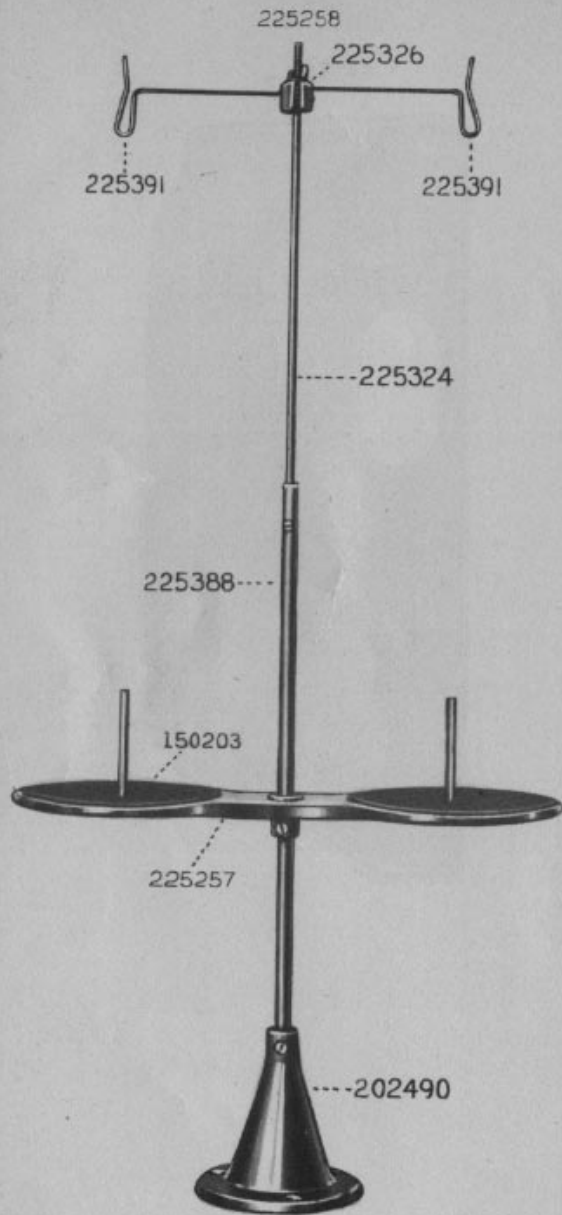

PLATE 21806—FULL SIZE

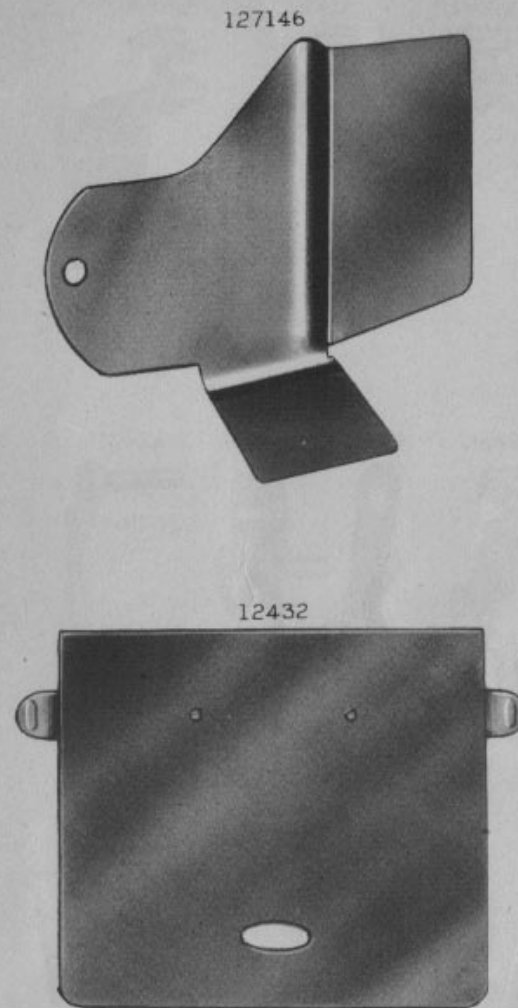

PLATE 21817—FULL SIZE

120828



35682



52056



36465



36464



36717



36715

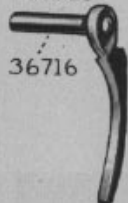

36716

665



233



35245

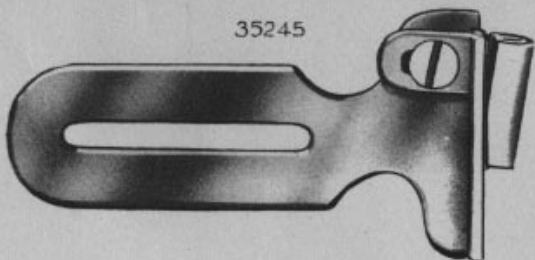
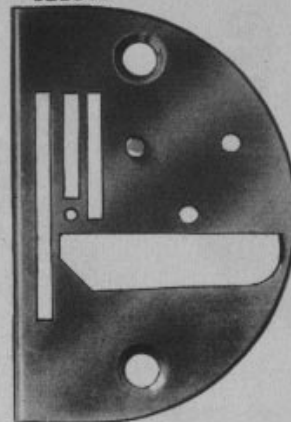
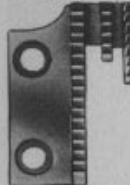

PLATE 21818—FULL SIZE

121398



121397



16teeth • 1 inch

43525



26605

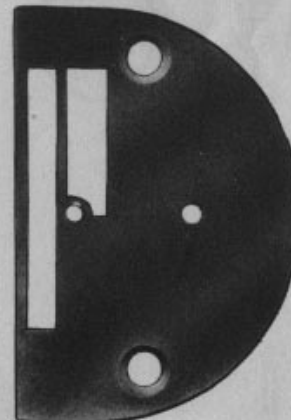

26603

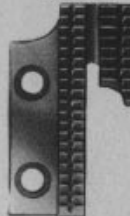

16teeth • 1 inch

PLATE 21819—FULL SIZE

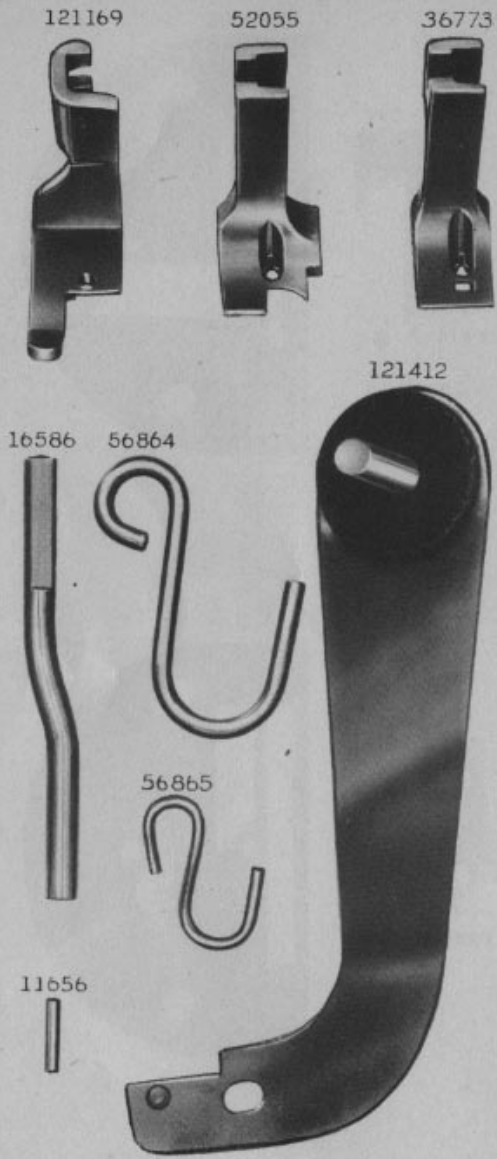

PLATE 21823—ONE-FOURTH SIZE

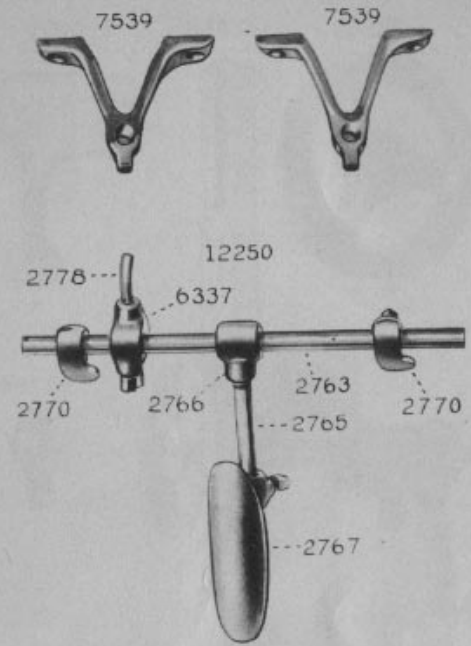

PLATE 21834—ONE-HALF SIZE

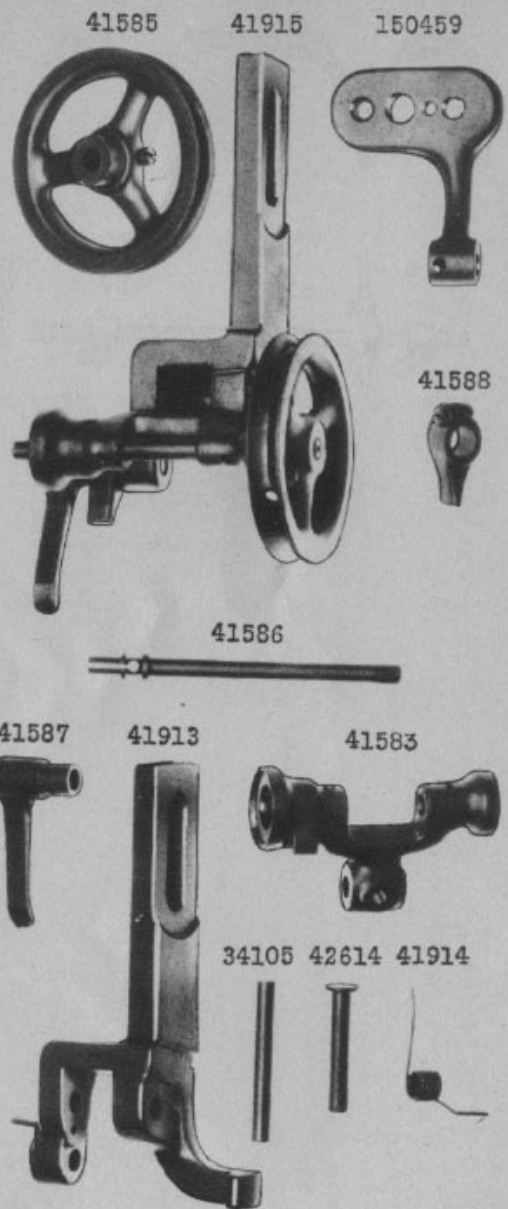

PLATE 21835—ONE-HALF SIZE

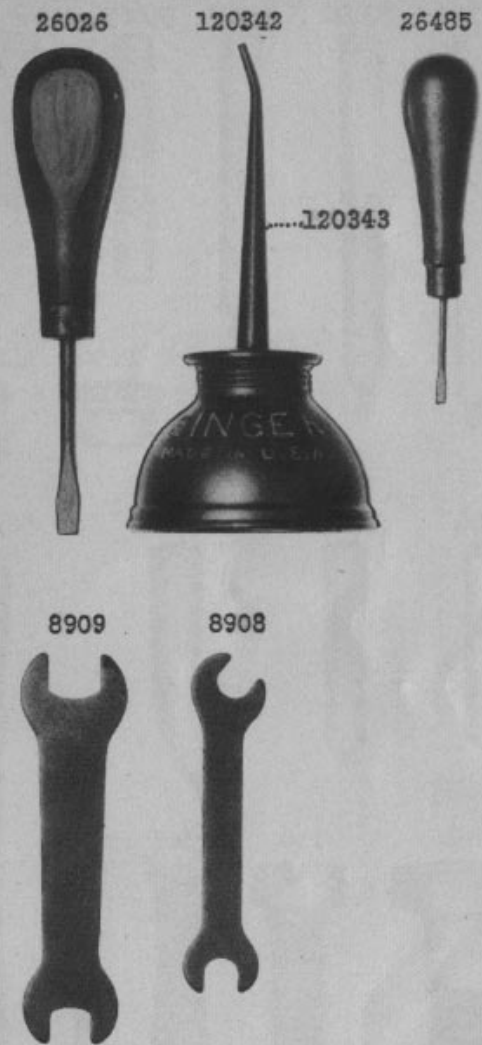

PLATE 22217 - FULL SIZE

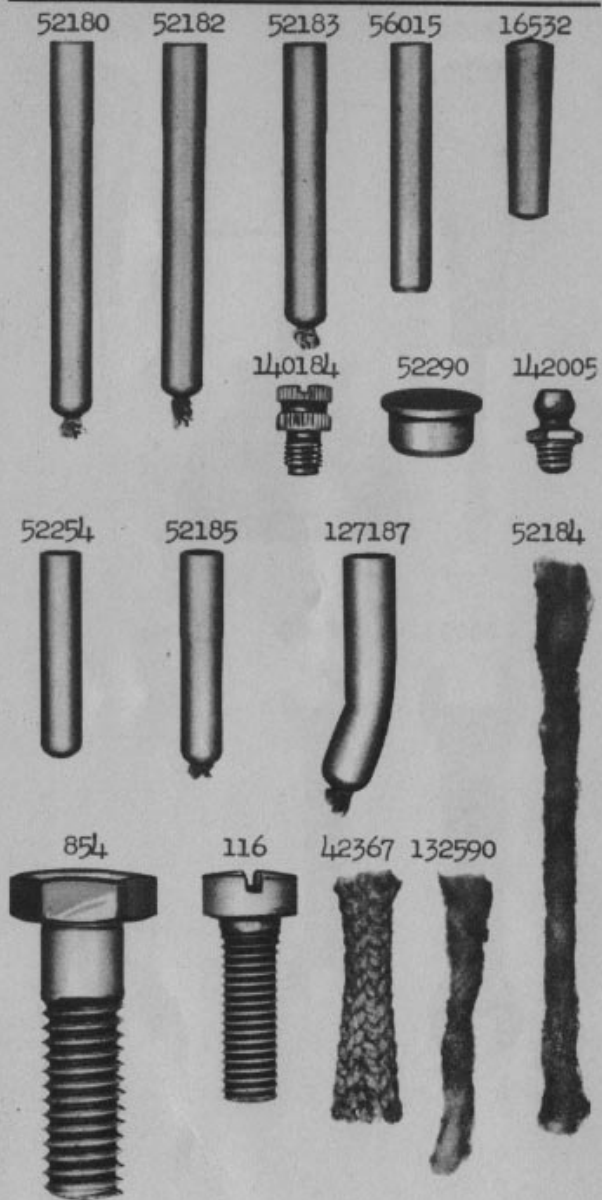

PLATE 22218 - FULL SIZE

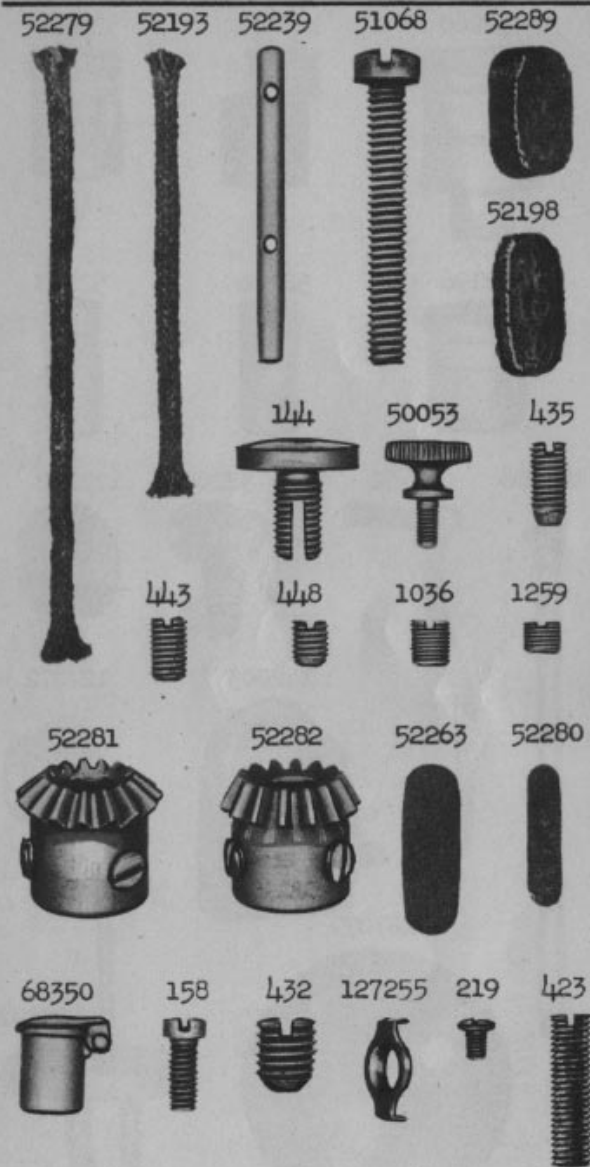

PLATE 22219 - ONE-HALF SIZE

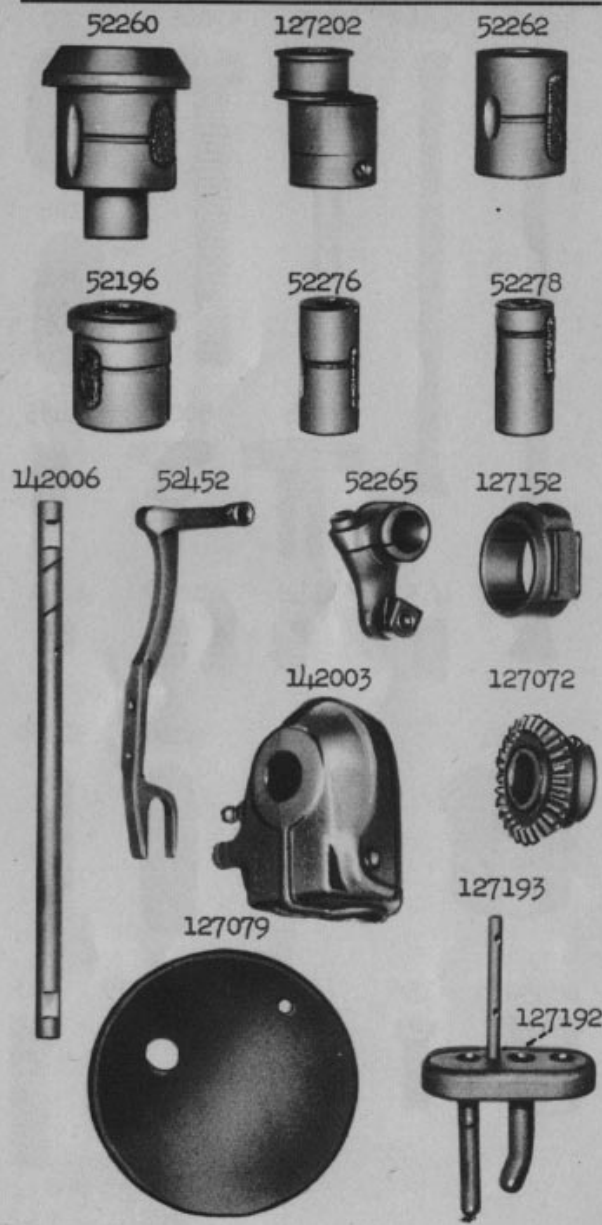

PLATE 22220 - FULL SIZE



From the library of: Diamond Needle Corp

PLATE 22221 - ONE-HALF SIZE

12391 127088 127108 52014 52286 52288

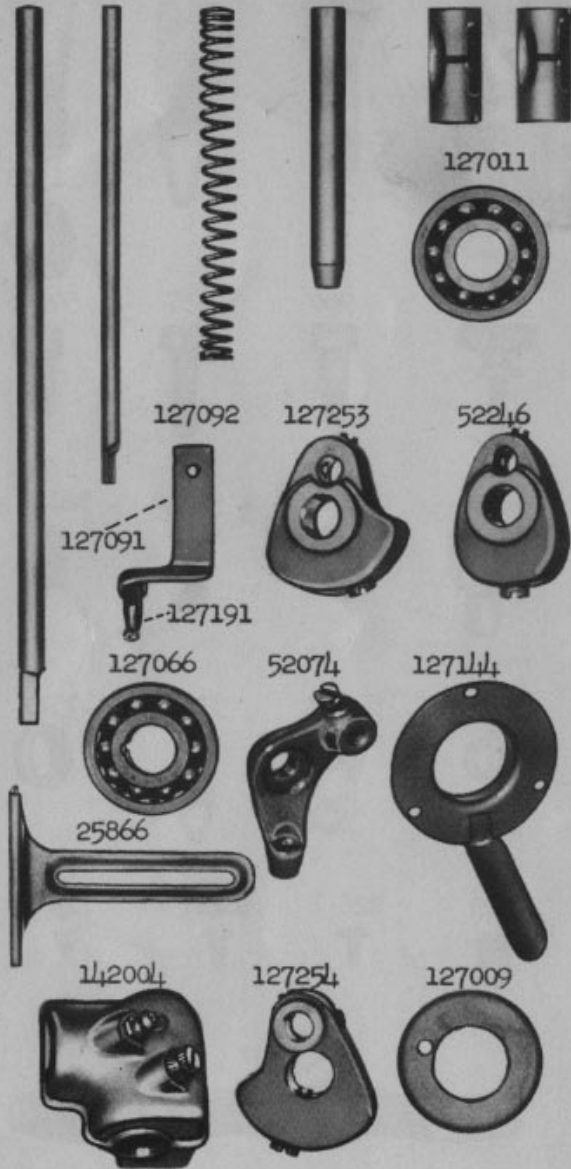

PLATE 22222 - FULL SIZE

127231 818 127230 24041



PLATE 22223 - ONE-FOURTH SIZE

127267 127265 52384 52386 127292 12237

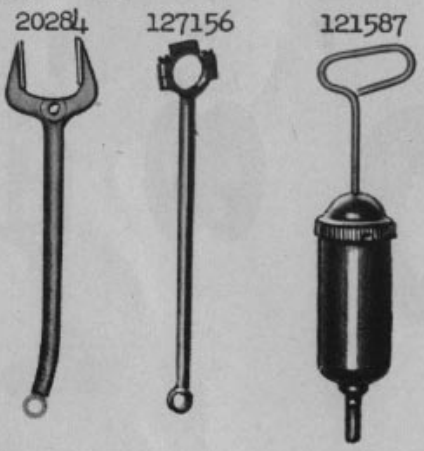
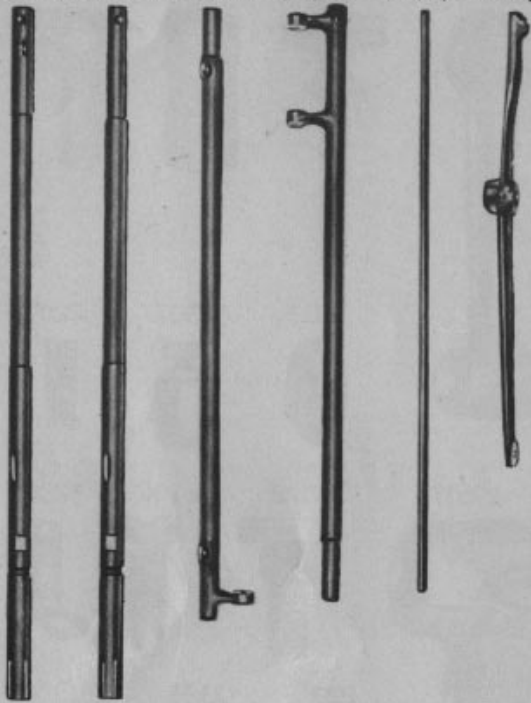

PLATE 22224 - FULL SIZE

52018

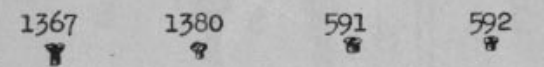
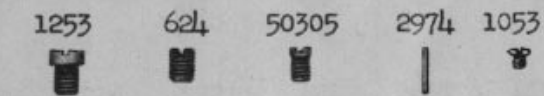
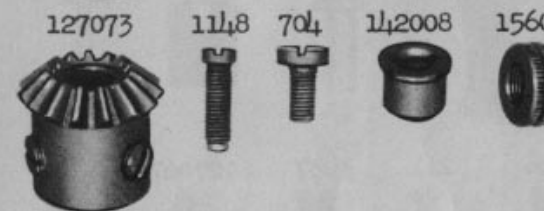
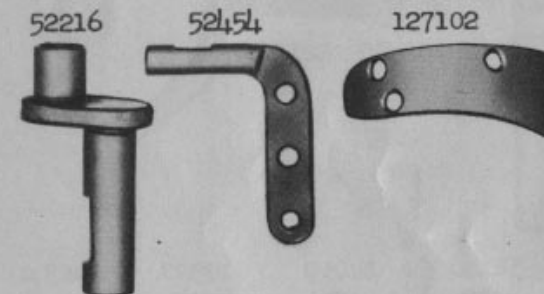
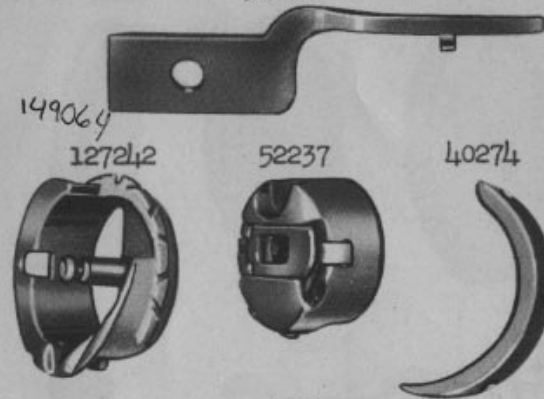

PLATE 22225 - FULL SIZE

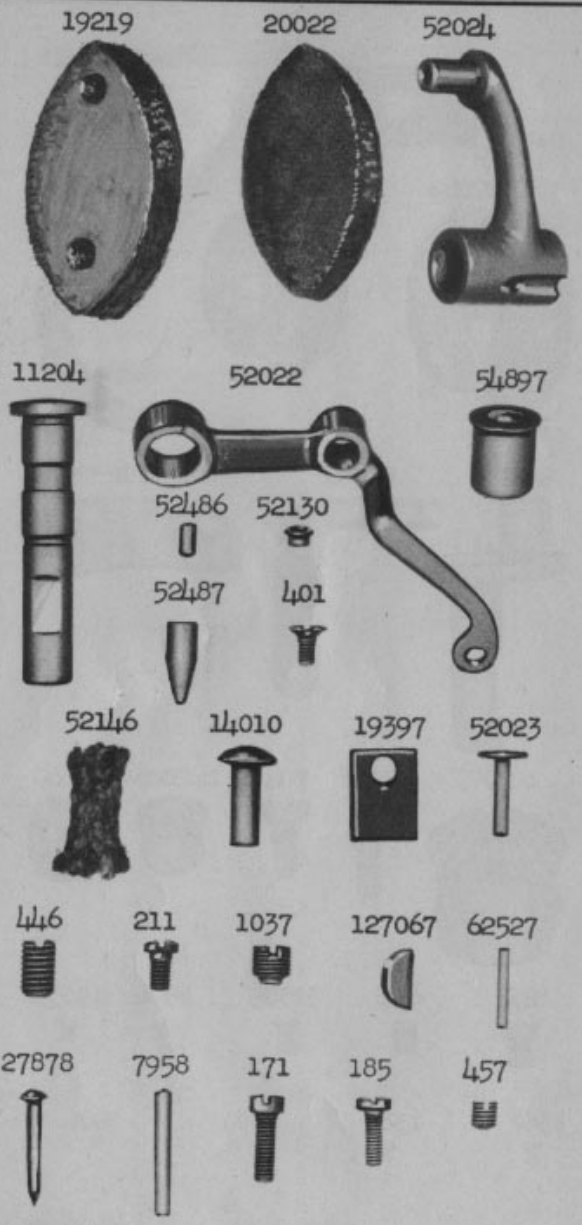

PLATE 22226 - ONE-HALF SIZE



PLATE 22227 - FULL SIZE

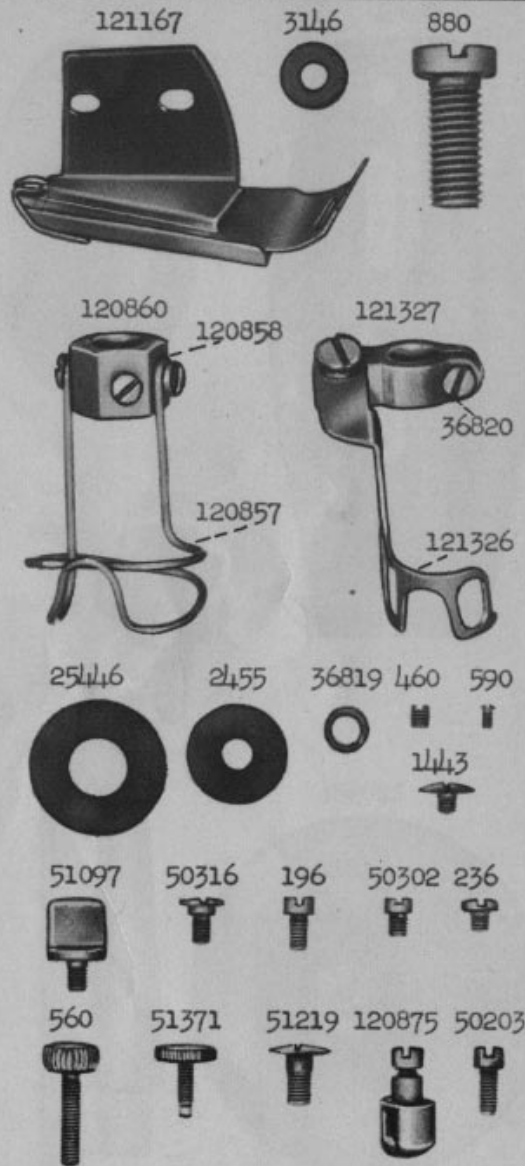

PLATE 22228 - FULL SIZE

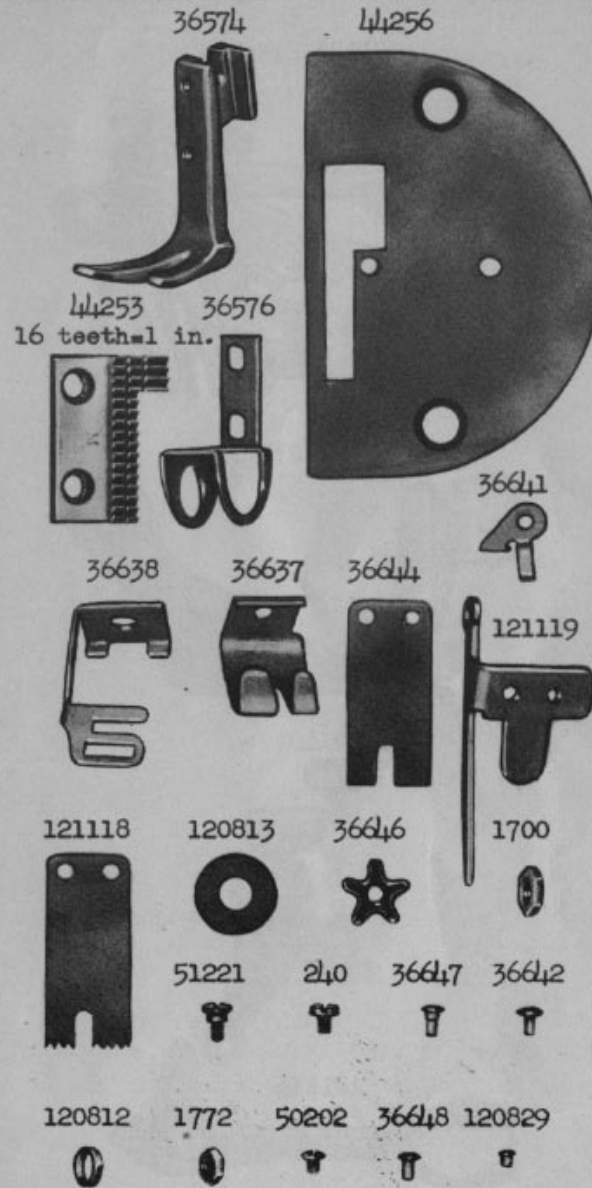
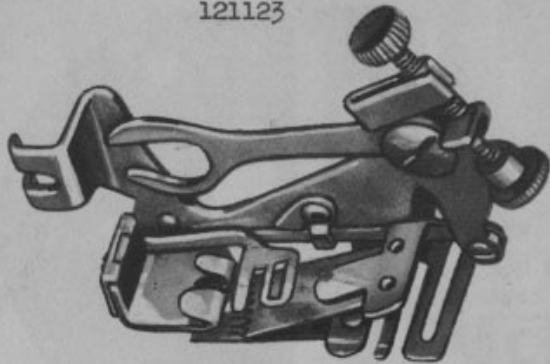

PLATE 22229 - FULL SIZE

121123



121117



121121



121116

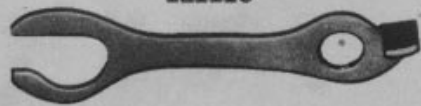

PLATE 22230 - FULL SIZE

12240



802



356



5601



76



225322



1521



178



208



201018



766



200383



4882



4883

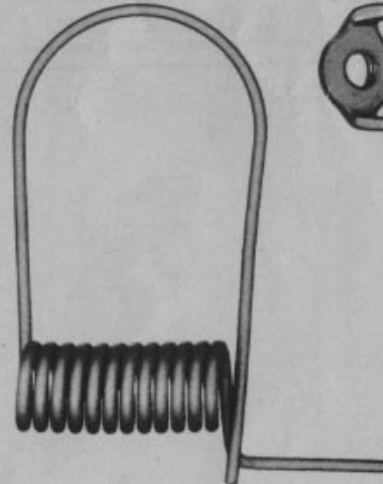

201696

